

***YAESU***

**AIR BAND TRANSCEIVER**

***FTA-850L***

**Bluetooth®**

**Operating Manual**

# CONTENTS

|  |    |  |    |
|--|----|--|----|
| Introduction.....  | 1  | Connect to another paired Bluetooth® headset.....            | 35 |
| Quick GUIDE.....   | 2  | VOX Operation.....   | 37 |
| SELECT THE SCREEN.....   | 4  | Reception of VOR Signals.....                                | 38 |
| MENU Screen.....   | 4  | Reception of ILS Signals.....                                | 41 |
| COMM Mode.....   | 5  | Split Operation.....   | 43 |
| MEMORY CH Mode.....  | 5  | Reception of Weather Channel Broadcasts.....                 | 45 |
| WEATHER CH Mode.....   | 6  | Dual Watch Operation.....                                    | 46 |
| GPS Compass Screen.....  | 6  | TOT Feature.....   | 47 |
| Navigation Screen.....   | 7  | Saving the Battery during Reception.....                     | 47 |
| Timer Screen.....  | 7  | Using the Headset Microphone.....                            | 48 |
| Dual Frequency Display (DD) Screen.....                                  | 8  | Side Tone Control.....                                       | 48 |
| VOR CDI Screen.....  | 9  | Changing the Channel Steps.....                              | 49 |
| ILS CDI Screen.....  | 9  | ANL Feature.....   | 49 |
| Function Menu Screen.....  | 10 | Compass display.....   | 50 |
| Important Notice!.....   | 11 | PTT Lock Function.....                                       | 50 |
| Accessories and Options.....   | 12 | Memory Operation.....  | 51 |
| Supplied Accessories.....  | 12 | Recalling the Memories.....                                  | 51 |
| Available Options.....   | 12 | Instant Storage.....   | 52 |
| Controls & Connectors.....   | 13 | Maintenance of the Memory.....                               | 52 |
| Right Side.....  | 15 | Scanning Operation.....                                      | 55 |
| Before You Begin.....  | 16 | Scanning Channels.....                                       | 55 |
| Battery Installation and Removal.....                                    | 16 | Selecting Scanning Band.....                                 | 56 |
| Batteries and Chargers.....  | 16 | Scanning the Memory Channels.....                            | 56 |
| Battery Charging.....  | 18 | Navigation.....  | 58 |
| Alkaline Battery Tray Installation.....                                  | 18 | Starting Navigation.....                                     | 58 |
| Battery Life Indication.....   | 19 | Select the destination or the route.....                     | 58 |
| External DC Power Supply Connection.....                                 | 19 | Route display during navigation.....                         | 62 |
| Antenna Installation.....  | 20 | Stopping navigation in progress.....                         | 63 |
| Belt Clip Installation.....  | 20 | Back to departure point.....                                 | 63 |
| Headset Connection.....  | 21 | Start a new navigation.....                                  | 64 |
| Precautions.....   | 21 | Save the route in memory.....                                | 64 |
| Basic Operation.....   | 22 | Edit the stored route.....                                   | 67 |
| Reception.....   | 22 | Delete the stored route.....                                 | 68 |
| Turning the radio on and off.....  | 22 | Timer FUNCTION.....  | 69 |
| Adjusting the frequency.....   | 23 | Using the stopwatch timer.....                               | 69 |
| Adjusting the volume.....  | 23 | Using the countdown timer.....                               | 70 |
| Adjusting the squelch.....   | 24 | GPS Function.....  | 72 |
| Monitor Switch.....  | 24 | Activating the GPS Unit.....                                 | 72 |
| Accessing the 121.5 MHz Emergency Frequency.....                         | 24 | Displaying the Position Information.....                     | 72 |
| Transmission (COM Band).....   | 25 | Memorizing the Position Information.....                     | 74 |
| Operation Bands.....   | 25 | Recording the Position Information.....                      | 74 |
| Operation Modes.....   | 26 | SETUP Mode.....  | 75 |
| Function Menus.....  | 27 | Basic Operation.....   | 75 |
| Lock Function.....   | 28 | Maintenance of the Memory.....                               | 76 |
| Factory Resetting the Radio.....   | 29 | Setting of the COMM Mode Operation.....                      | 76 |
| Advanced Operation.....  | 30 | Setting of the GPS Mode Operation.....                       | 79 |
| DD (Dual Frequency Display).....   | 30 | Setting of the Bluetooth Operation.....                      | 83 |
| DD (Dual Frequency Display) mode operation.....                          | 31 | Setting of the Operation and Configuration of the Radio..... | 83 |
| Bluetooth® Operation.....  | 32 | About the Radio.....   | 84 |
| Pairing the Bluetooth® Headset.....                                      | 32 | Summary of the SETUP Menu.....                               | 85 |
| Transmit operation by pressing the button on the Bluetooth® headset..... | 34 | Specifications.....  | 87 |
| Hands-free VOX operation with a Bluetooth® headset.....                  | 34 | Troubleshooting for Headset Connection.....                  | 89 |
| Disconnect the connected Bluetooth® headset.....                         | 34 | Safety Precautions.....                                      | 91 |

## INTRODUCTION

The YAESU **FTA-850L** is a compact, stylish, solid hand-held transceiver that provides transmit and receive capability on the International Aircraft Communication Band (“COM” band: 118 to 136.975 MHz), and additionally provides VOR and ILS navigation features on the “NAV” band (108 to 117.975 MHz).

It uses a 2.4 inch (49 x 37 mm) 320 x 240 dot, full-color TFT LCD to display a large amount of information in an easy-to-understand format. With the DD (Dual frequency Display) function, two channels are displayed at the top and bottom of the screen. The active channel can be switched instantly by simply pressing the ▲/▼ keys. A flight route navigation function operates with a highly sensitive built-in GPS unit. In addition, the standard Bluetooth® unit enables hands-free operation using the optional SSM-BT10 or a commercially available Bluetooth® headset. An intuitive menu screen with icon display is adopted, and frequently used functions can be activated immediately during operation.

The **FTA-850L** include NOAA weather band monitoring and 400 memory channels. The channel configurations can be easily reprogrammed in minutes using the optional PC Programming Software and your PC, and additionally provide positioning and navigation features realized by the internal GPS unit.

We recommend that you read this manual in its entirety, so as to understand the many features of the **FTA-850L** completely. Keep this manual handy, so you may use it for reference.

**Note: The VOR, ILS, and GPS navigation features of the FTA-850L is for supplemental aids to navigation only, and are not intended to be a substitute for accurate (primary) VOR or landing service equipment. You assume full responsibility for the use of the FTA-850L.**

### Congratulations!

You now have at your fingertips a valuable communications tool, a YAESU two-way radio! Rugged, reliable and easy to use, your YAESU radio will keep you in constant touch with your friends and colleagues for years to come, with negligible maintenance or down-time.

Please take a few minutes to read this manual carefully. The information presented here will allow you to derive maximum performance from your radio, in case questions arise later on.

We're glad you joined the YAESU team. YAESU products cover the entire spectrum of radio communications applications, and our worldwide support network is here to serve you. Let us help you get your message across.

## QUICK GUIDE

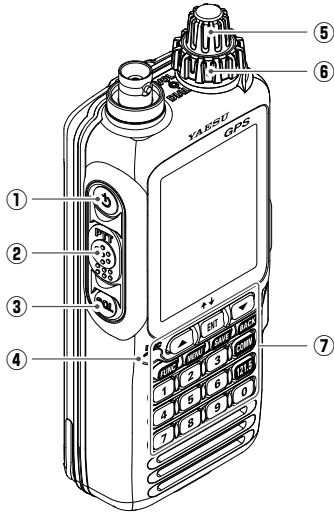

- ① **POWER Switch**  
Press and hold this switch to turn the radio ON or OFF.
- ② **PTT (Push To Talk) Switch**
- ③ **SQL (Squelch) Switch**  
Open the squelch, and adjust the squelch level.
- ④ **Microphone**
- ⑤ **VOLUME (Inner) Knob**
- ⑥ **DIAL (Outer) Knob**

### ⑦ Keypad

#### [▲]/[▼] Keys

- On the COMM screen, use these keys to select a previously used frequency, and then press the [ENT] key to recall it.
- On the DD (Dual frequency Display) screen, use these keys to switch the active channel.
- Use these keys to select an item displayed on the LCD.

#### [ENT] Key

- Determine the selection or entered values.
- On the DD (Dual frequency Display) screen, use this key to switch the display mode.

#### [FUNC] Key

Press this key to display the Function menu screen.

#### [MENU] Key

- Press this key to display the MENU screen.
- Press and hold this key to display the SETUP menu screen.

#### [SAVE] Key

Press and hold this key to store the current channel information to the memory.

#### [BACK] Key (LOCK Key)

- Press this key to return the display to the previous screen.
- Press and hold this key to turn the lock feature ON or OFF.

#### [COMM] Key

Press this key to enter the COMM mode instantly.

#### [121.5] Key

Press and hold this key to access the emergency frequency (121.5 MHz) instantly.

#### Numeric Keypad

The keypad is used when setting frequencies.

## HOW TO USE

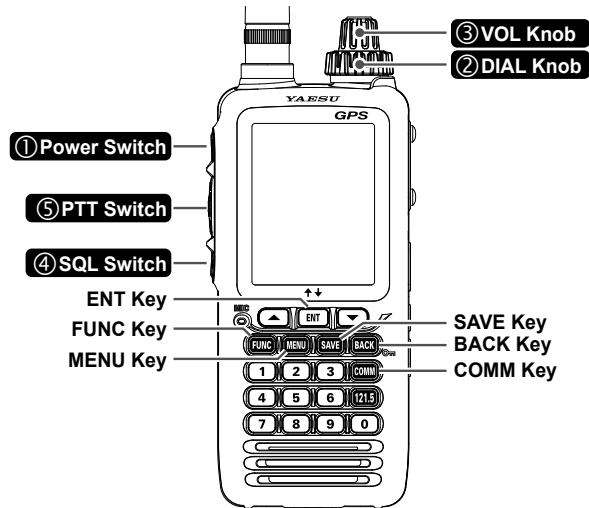

- ① Turn the Power ON
- ↓
- ② Tune to the frequency (Rotate the **DIAL** knob)
- ↓
- ③ Adjust the volume (Rotate the **VOL** knob)
- ↓
- ④ Adjust the squelch  
(Press the **SQL** switch → Rotate the **DIAL** knob)
- ↓
- ⑤ Transmitting (Press the **PTT** switch)

## BASIC OPERATIONS

### Recall the previously used frequency (COMM Mode)

Press the ▲/▼ key to select the frequency.  
↓  
Press the [ENT] key

### Registering Channels to Memory

#### Registering Memories

Tune to the frequency.  
↓  
Press and hold the [SAVE] key.  
↓  
Press the [SAVE] key.

#### Recalling Memories

Press the [MENU] key.  
↓  
Press the ▲/▼ key or rotate the **DIAL** knob to select "MEMORY".  
↓  
Press the [ENT] key.  
↓  
Press the ▲/▼ key or rotate the **DIAL** knob to select the Memory channel.

# SELECT THE SCREEN

## MENU Screen (Page 26)

Press the ▲/▼ key or rotate the DIAL knob to select the Mode.

Press the [MENU] key

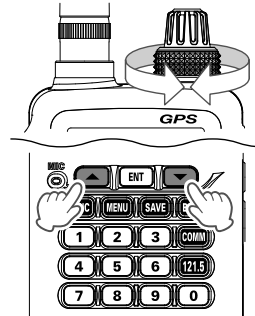
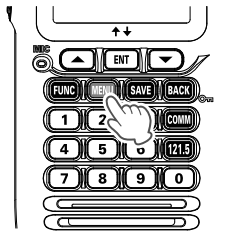

Press the [ENT] key



To return to the previous screen press the [BACK] key during the operation.

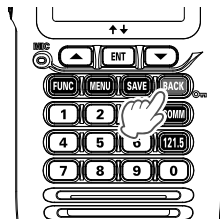

In "SETUP" on the MENU screen, you can make various settings for the radio and settings related to communication. See page 75 for details.



## ① COMM Mode (Page 22)

Press the [MENU] key → Select “COMM” → Press the [ENT] key / or Press the [COMM] key



Press the [ENT] key



The **BUSY** icon is displayed during reception and the **TX** icon is displayed during transmission.

The operating frequency is displayed. The frequency may be changed by turning the DIAL knob or using the number keys.

The name (tag) of the current channel is displayed.

Previously used frequencies are displayed in order from the top. A previous frequency may be recalled by pressing the ▲ / ▼ keys to select it, and then pressing the [ENT] key.

Icons indicating GPS function, logger function, timer function, Bluetooth function, remaining battery level (5 levels), and charging status are displayed.

An icon indicating the status of the dual watch function, ANL function, VOX function, and split function is displayed.

The volume or squelch level is displayed.

To change the screen

- Press the [MENU] key to select the desired screen, and then press the [ENT] key.
- Pressing the [BACK] key does not return to the previous screen.

## ② MEMORY CH Mode (Page 51)

Press the [MENU] key → Select “MEMORY” → Press the [ENT] key  
 MEMORY CH mode cannot be called if nothing is stored in memory.



Press the [ENT] key



The memory group name is displayed. Switch groups by pressing and holding the [ENT] key.

The memory channels (frequency and tag) are displayed. Select a channel by pressing the DIAL knob or the ▲/▼ keys.

The operating frequency is displayed.

The name (tag) of the current memory channel is displayed.

The current memory channel is highlighted.

To change the screen

- Press the [COMM] key to return to COMM mode
- Press the [MENU] key to select the desired screen, and then press the [ENT] key.
- Pressing the [BACK] key does not return to the previous screen.

### ③ WEATHER CH Mode (Page 45)

Press the [MENU] key → Select “WEATHER” → Press the [ENT] key

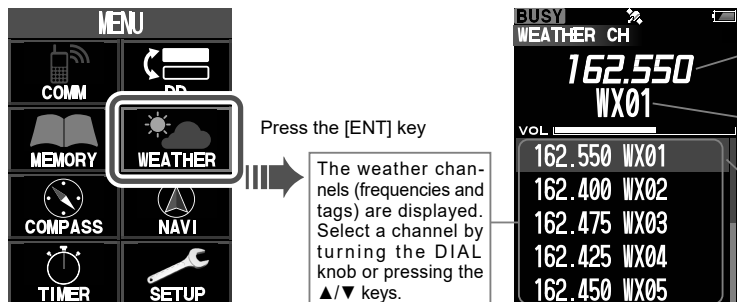

Press the [ENT] key

The weather channels (frequencies and tags) are displayed. Select a channel by turning the DIAL knob or pressing the ▲/▼ keys.

The frequency of the weather channel is displayed.

The name (tag) of the current weather channel is displayed.

The current memory channel is highlighted.

To change the screen

- Press the [COMM] key to return to COMM mode
- Press the [MENU] key to select the desired screen, and then press the [ENT] key.
- Pressing the [BACK] key does not return to the previous screen.

### ④ GPS Compass Screen (Page 50)

Press the [MENU] key → Select “COMPASS” → Press the [ENT] key

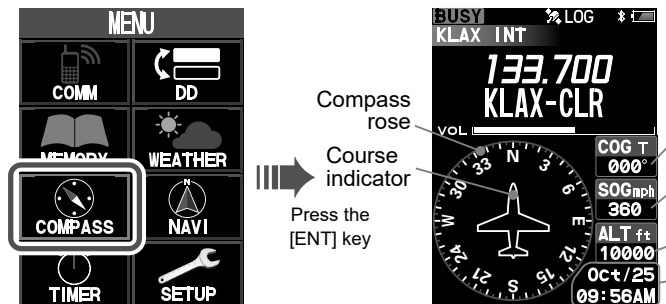

Press the [ENT] key

Compass rose

Course indicator

Press the [ENT] key

COG (course over ground) value

SOG (speed over ground) value

Altitude value

Date obtained from the GPS signal

To change the screen

- Press the [COMM] key to return to COMM mode
- Press the [MENU] key to select the desired screen, and then press the [ENT] key.
- Press the [BACK] key to return to the previous screen.



## ⑤ Navigation Screen (Page 58)

Press the [MENU] key → Select "NAVI" → Press the [ENT] key



To change the screen

- Press the [COMM] key to return to COMM mode
- Press the [MENU] key to select the desired screen, and then press the [ENT] key.
- Press the [BACK] key to return to the previous screen.

## ⑥ Timer Screen (Page 69)

Press the [MENU] key → Select "TIMER" → Press the [ENT] key

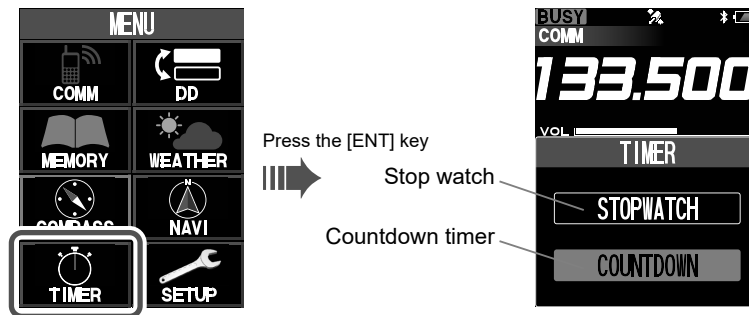

To change the screen

- Press the [COMM] key to return to COMM mode
- Press the [MENU] key to select the desired screen, and then press the [ENT] key.
- Press the [BACK] key to return to the previous screen.

## ⑦ Dual Frequency Display (DD) Screen (Page 30)

Two frequencies can be displayed separately on the top and bottom of the screen.

For example, if the upper section is set to COMM mode and the lower section is set to MEMORY CH mode, you can instantly switch between COMM mode and MEMORY CH mode by simply pressing the ▲/▼ keys.

Press the [MENU] key → Select “DD” → Press the [ENT] key

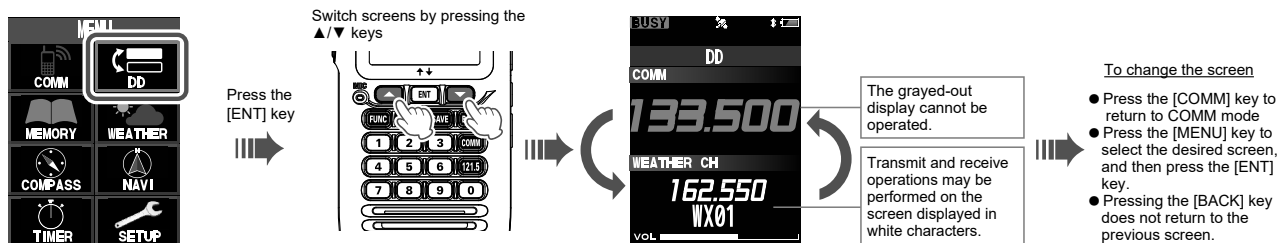

Press the [ENT] key to switch the screen modes that can be operated.

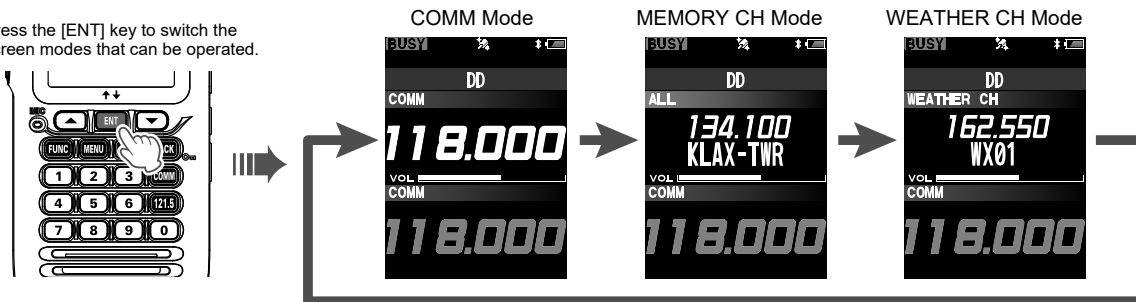

- ⑧ When a VOR or ILS signal is received, it automatically switches to the VOR CDI screen or ILS CDI screen and continues to display while the signal is being received. When there is no signal, it automatically returns to the previous screen.

## VOR CDI Screen (Page 38)



### To change the screen

- Press the [ENT] key to return to the previous screen. If there is a signal, the VOR CDI screen will be displayed again after about 15 seconds.
- Pressing the [COMM] key does not return to COMM mode.
- Press the [MENU] key to select the desired screen and press the [ENT] key.
- Pressing the [BACK] key does not return to the previous screen.

## ILS CDI Screen (Page 41)

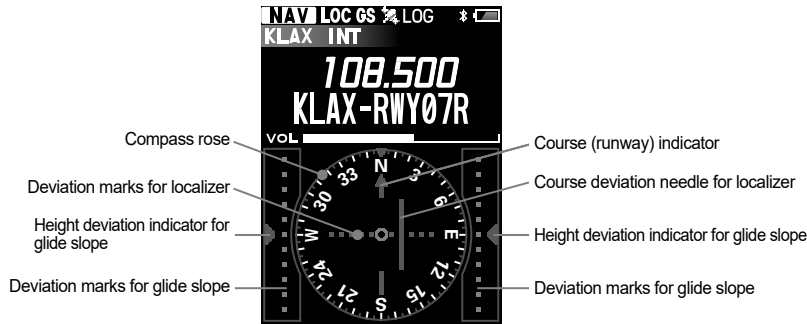

### To change the screen

- Press the [ENT] key to return to the previous screen. If there is a signal, the ILS CDI screen will be displayed again after about 15 seconds.
- Pressing the [COMM] key does not return to COMM mode.
- Press the [MENU] key to select the desired screen and press the [ENT] key.
- Pressing the [BACK] key does not return to the previous screen.

## ⑨ Function Menu Screen

Press the [FUNC] key to display the currently available function screens.

Access the functions just by pressing a number on the numeric keypad of the desired function listed on the display.

Press the [FUNC] key 

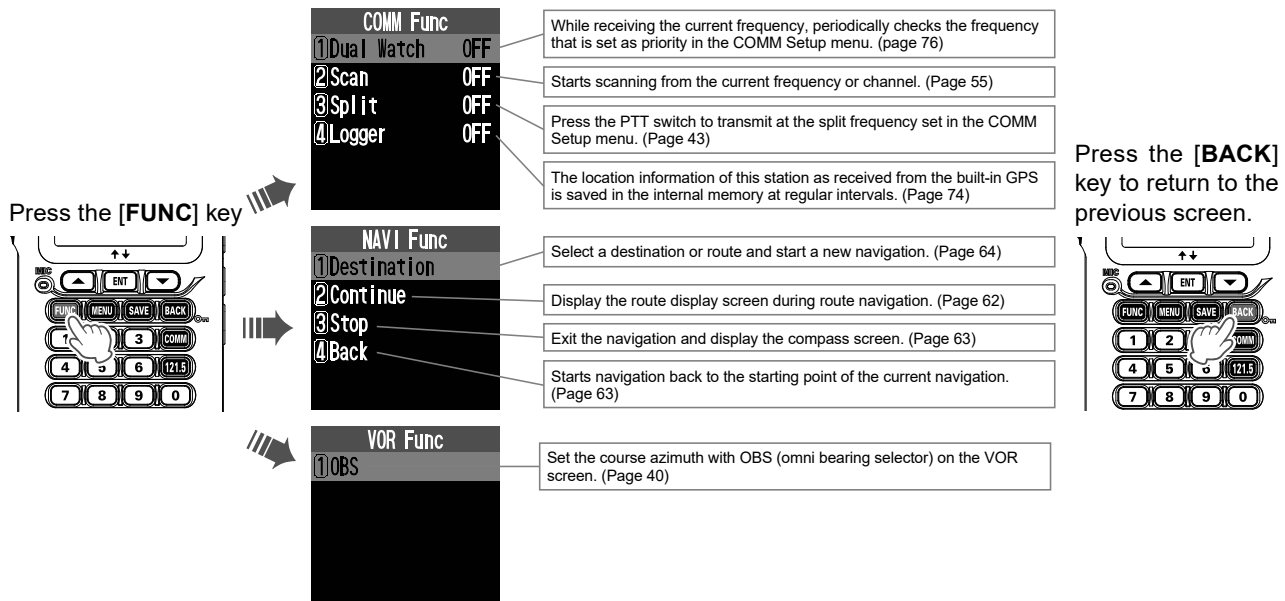

| COMM Func   |     |  |
|-------------|-----|--|
| ①Dual Watch | OFF | While receiving the current frequency, periodically checks the frequency that is set as priority in the COMM Setup menu. (page 76)         |
| ②Scan       | OFF | Starts scanning from the current frequency or channel. (Page 55)   |
| ③Split      | OFF | Press the PTT switch to transmit at the split frequency set in the COMM Setup menu. (Page 43)  |
| ④Logger     | OFF | The location information of this station as received from the built-in GPS is saved in the internal memory at regular intervals. (Page 74) |

| NAVI Func    |  |   |
|--------------|--|---|
| ①Destination |  | Select a destination or route and start a new navigation. (Page 64)               |
| ②Continue    |  | Display the route display screen during route navigation. (Page 62)               |
| ③Stop        |  | Exit the navigation and display the compass screen. (Page 63)                     |
| ④Back        |  | Starts navigation back to the starting point of the current navigation. (Page 63) |

| VOR Func |  |  |
|----------|--|--|
| ①OBS     |  | Set the course azimuth with OBS (omni bearing selector) on the VOR screen. (Page 40) |

Press the [BACK] key to return to the previous screen.

## IMPORTANT NOTICE!

### FCC RF Exposure Compliance Requirements for Occupational Use Only:

The **FTA-850L** have been tested and comply with the Federal Communications Commission (FCC) RF exposure limits for Occupational Use/Controlled Exposure Environment. In addition, both radios comply with the following Standards and Guidelines:

- FCC 96-326, Guidelines for Evaluating the Environmental Effects of Radio-Frequency Radiation.
- FCC OET Bulletin 65 Edition 97-01 (1997) Supplement C, Evaluating Compliance with FCC Guidelines for Human Exposure to Radio Frequency Electromagnetic Fields.
- ANSI/IEEE C95.1-1992, IEEE Standard for Safety Levels with Respect to Human Exposure to Radio Frequency Electromagnetic Fields, 3 kHz to 300 GHz.
- ANSI/IEEE C95.3-1992, IEEE Recommended Practice for the Measurement of Potentially Hazardous Electromagnetic Fields - RF and Microwave.
- This radio is NOT approved for use by the general population in an uncontrolled environment. This radio is restricted to occupational use, work related operations only where the radio operator must have the knowledge to control its RF exposure conditions.**
- When transmitting, hold the radio in a vertical position with its microphone 1 to 2 inches (2.5 to 5 cm) away from your mouth and keep the antenna at least 1 inch (2.5 cm) away from your head and body.**
- The radio must be used with a maximum operating duty cycle not exceeding 75%, in typical Push-to-Talk configurations. DO NOT transmit for more than 75% of total radio use time (75% duty cycle). Transmitting more than 75% of the time can cause FCC RF exposure compliance requirements to be exceeded. The radio is transmitting when the "TX" icon is displayed on the upper left corner of the screen of the radio. You can cause the radio to transmit by pressing the PTT button.**
- Always use YAESU authorized accessories.**

#### NOTICE

*There are no user-serviceable points inside this transceiver.  
All service jobs must be referred to your Authorized Service Center.*

## ACCESSORIES AND OPTIONS

### Supplied Accessories

|  |                  |
|--|------------------|
| <b>Lithium-ion Battery Pack<br/>(7.2V 2200mAh)</b> | <b>SBR-39LI</b>  |
| <b>AC Charger</b>                                  | <b>SAD-25</b>    |
| <b>Charger Cradle</b>                              | <b>SBH-11</b>    |
| <b>Cigarette Lighter DC/DC Converter</b>           | <b>SDD-12</b>    |
| <b>Helical Antenna</b>                             | <b>SRA-20A*1</b> |
| <b>Belt Clip</b>                                   | <b>SHB-11</b>    |
| <b>Headset Adapter Cable</b>                       | <b>SCU-42</b>    |
| <b>Alkaline Battery Tray</b>                       | <b>SBT-12</b>    |
| <b>USB Cable</b>                                   | <b>T9101648</b>  |
| <b>Ferrite Core</b>                                | <b>L9190192</b>  |
| <b>Operating Manual</b>                            |                  |

### Available Options

|   |                  |
|---|------------------|
| <b>Bluetooth® Headset</b>   | <b>SSM-BT10</b>  |
| <b>Speaker Microphone</b>   | <b>SSM-20A</b>   |
| <b>Earphone</b><br><i>*2(available only with the SSM-20A)</i>               | <b>SEP-10A*2</b> |
| <b>Earphone</b>   | <b>SEP-11A</b>   |
| <b>Quick Release Holster</b>  | <b>SHB-110</b>   |
| <b>Belt Clip Hanger</b>   | <b>SCH-11</b>    |
| <b>PC Programming Software</b>  | <b>YCE46</b>     |
| <i>(Download the YCE46 PC Programming Software from the YAESU website.)</i> |                  |

*Availability of accessories may vary. Some accessories are supplied as standard per local requirements, while others may be unavailable in some regions. Consult your YAESU Dealer for details regarding these and any newly-available options. Connection of any non-YAESU-approved accessory, should it cause damage, may void the Limited Warranty on this apparatus.*

\*1 Antenna gain: 2.15 dBi  
Impedance: 50 ohms

## CONTROLS & CONNECTORS

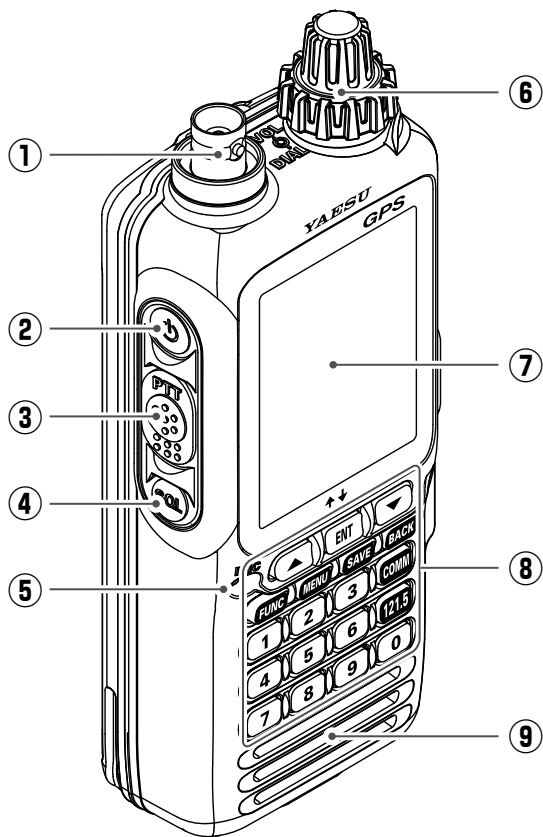

- ① **Antenna Jack**  
This BNC connector accepts the supplied flexible antenna, or an external antenna designed to provide 50  $\Omega$  impedance on the Aircraft Communication Band.
- ② **POWER Switch**  
Press and hold this button to turn the radio ON or OFF.
- ③ **PTT (Push To Talk) Switch**  
Press and hold this button to transmit when you are operating in the COM band. Release this button to return to the “Receive” mode. See page 25 for details.
- ④ **SQL (Squelch) Switch**  
Adjust the squelch level by pressing this button, and then turning the **DIAL** knob. Press and hold this button to “open” the squelch continuously. Press this button again to resume normal (quiet) monitoring. See page 24 for details.
- ⑤ **Microphone**  
Speak into this opening in a normal voice level, while pressing the **PTT** switch, to transmit.
- ⑥ **VOLUME (Inner) Knob**  
Turn this (inner) knob control clockwise to increase the volume.

### DIAL (Outer) Knob

This (outer) knob tunes the operating frequency or selects the memory channels.

### ⑦ LCD (Liquid Crystal Display)

The display shows selected operating conditions, as indicated on Pages 4 to 10.

### ⑧ Keypad

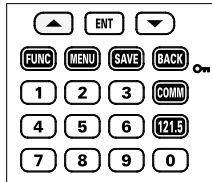

### Cursor Keys

- You can select a previously used frequency on the COMM screen and press the [ENT] key to recall it and switch it to the active channel on the DD (Dual Frequency Display) screen.
- The cursor keys [▲] and [▼] are used to select an item displayed on the LCD.

### ENT Key

- Press the [ENT] key to determine the selection or entered values.
- In memory mode, press and hold the [ENT] key to switch memory groups.
- Each time you press the DD (Dual Frequency Display) screen, operation is switched between
- COMM mode, memory mode, and WEATHER CH.

- Press on the COMPASS, NAVI, TIMER, VOR, ILS, Location INFO, or GPS INFO screen to display the previously used frequency history selection screen or the memory channel / WX channel selection screen.

### FUNC Key

Press this key to display the Function menu screen.

### MENU Key

- Press this key to display the MENU screen.
- Press and hold this key to display the SETUP menu screen.

### SAVE Key

Press and hold this key to store the current channel information to the memory.

### BACK Key (LOCK Key)

- Press this key to return the display to the previous screen.
- Press and hold this key to enable the lock feature. Controls and keys will be disabled. Press and hold again to disable the lock feature.

### COMM Key

Press this key to enter the COMM mode instantly.

### 121.5 Key

Press and hold this key to access the emergency frequency (121.5 MHz) instantly.

### Numeric Keypad

The keypad is used when setting frequencies.

### ⑨ Loudspeaker



## Right Side

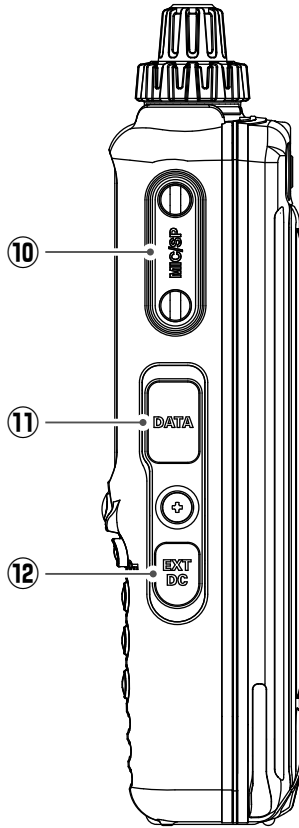

### ⑩ MIC/SP Jack

You may connect the supplied **SCU-42** Head-set Adapter Cable, or the optional **SSM-20A** Speaker/Microphone, or **SEP-11A** Earphone to this jack. To use this jack, you must first remove the cover from the transceiver body.



***Do not allow the FTA-850L to get wet while the cover over the MIC/SP jack is removed.***

### ⑪ DATA Jack

You may connect the optional USB cable to this jack. To use this jack, you must first lift the rubber cover away from the transceiver body.



***Do not allow the FTA-850L to get wet while the rubber cover is removed.***

### ⑫ EXT DC Jack

When an external 9.5 to 10.5 Volt DC power source is available, you may connect the **SDD-12** Cigarette Lighter DC/DC Converter here.



***1) Do not allow the FTA-850L to get wet while the rubber cover is removed.***

***2) Do not connect any accessory unapproved by YAESU to supply DC power.***

# BEFORE YOU BEGIN

## Battery Installation and Removal

- ❑ To install the battery, insert the battery pack **SBR-39LI** into the battery compartment on the back of the transceiver, press the end of the battery pack while pressing the battery pack latch on the bottom of the transceiver, then lock the pack by sliding the locking plate beside the latch until the entire “**LOCK**” appears.

### Notes:

- Be sure that the rubber gasket on the **SBR-39LI** is not loose when inserting.
- The battery lock must be set to “**LOCK**” position to ensure water integrity and keep the battery from coming loose.

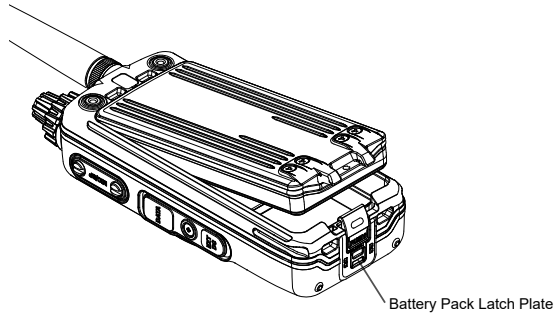

- ❑ To remove the battery, turn the transceiver off, slide the locking plate until the “**UNLOCK**” appears

entirely, lift up the end of the battery pack by pressing the battery pack latch, then pull out the battery from the radio.



***Do not attempt to open any of the rechargeable Lithium-ion packs, as personal injury or damage to the Lithium-ion pack could occur if a cell or cells become accidentally short-circuited.***

## Batteries and Chargers

The SBR-39LI is a high-performance Li-ion battery providing high capacity in a compact package.

### SBR-39LI Rechargeable Battery Pack

|                 |          |
|-----------------|----------|
| Capacity        | 2200 mAh |
| Nominal Voltage | 7.2 V    |

| Temperature Range | Minimum |    | Maximum |     |
|-------------------|---------|----|---------|-----|
|                   | °C      | °F | °C      | °F  |
| Charge            | 10      | 50 | 45      | 113 |
| Discharge         | -20     | -4 | 60      | 140 |
| Storage           | -20     | -4 | 40      | 104 |

### CAUTION

To avoid risk of explosion and injury, **SBR-39LI** battery pack should only be removed, charged or recharged in non-hazardous environments.

## ● Battery Safety

Battery packs for your transceiver contain Li-ion batteries. This type of battery stores a charge powerful enough to be dangerous if misused or abused, especially when removed from the transceiver. Please observe the following precautions:

### **DO NOT SHORT BATTERY PACK TERMINALS:**

Shorting the terminals that power the transceiver can cause sparks, severe overheating, burns, and battery cell damage. If the short is of sufficient duration, it is possible to melt battery components. Do not place a loose battery pack on or near metal surfaces or objects such as paper clips, keys, tools, etc. When the battery pack is installed on the transceiver, the terminals that transfer current to the transceiver are not exposed. The terminals that are exposed on the battery pack when it is mounted on the transceiver are charging terminals only and do not constitute a hazard.

**DO NOT INCINERATE:** Do not dispose of any battery in a fire or incinerator. The heat of fire may cause battery cells to explode and/or release dangerous gases.

## ● Battery Maintenance

For safe and proper battery use, please observe the following:

- Battery packs should be charged only in non-hazardous environments.
- Do not attempt charge a pack with the incorrect charger, as this can damage or shorten the life of the pack.
- Keep the battery contacts clean.

## ● Battery Storage

When a battery pack is not used for a long time, please remove it from the transceiver. Also, while in storage, the charge will drain slightly over time and the battery should be recharged 50% each six months.

## ● Battery Recycling

**DO NOT PLACE USED BATTERIES IN YOUR REGULAR TRASH!**

**LI-ION BATTERIES MUST BE COLLECTED, RECYCLED OR DISPOSED OF IN AN ENVIRONMENTALLY SOUND MANNER.**

The incineration, land filling or mixing of Li-ion batteries with the municipal solid waste stream is PROHIBITED BY LAW in most areas.

Return batteries to an approved Li-ion battery recycler. This may be where you purchased the battery.

Contact your local waste management officials for other information regarding the environmentally sound collection, recycling and disposal of Li-ion batteries.





**Li-ion**

## Battery Charging

If the radio has never been used, or its charge is depleted, it may be charged by connecting the **SBH-11** Charger Cradle with the **SAD-25** AC Adaptor.

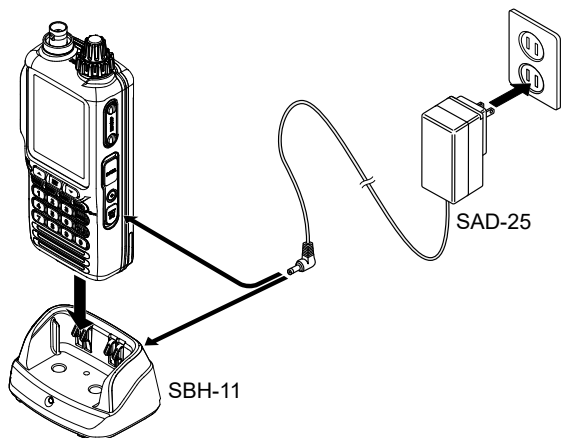
1. Install the Lithium-ion battery pack onto the transceiver. Ensure that the transceiver is switched off.
2. Referring to the figure at the right, connect the battery charger plugs.
3. Insert the transceiver into the **SBH-11**.



You may insert the cable plug of the **SAD-25** into the **EXT DC** jack located on the right side of the transceiver directly. In this case, the “” icon will appear in the top right corner of the LCD display.

4. If the transceiver is inserted correctly, the RED indicator on the **SBH-11** will glow.

- A fully-discharged pack will be charged completely in 5.5 hours, and then the GREEN indicator on the **SBH-11** will glow.
- It takes 10 hours for full charge with the **SAD-25** connected to the transceiver directly.

### Important Notes:

- The **SAD-25** is not designed to power the transceiver for operation (transmission).
- Do not leave the charger connected to the transceiver for continuous periods in excess of 24 hours. Long term overcharging can degrade the Lithium-ion battery pack and significantly shorten its useful life.

## Alkaline Battery Tray Installation

The supplied **SBT-12** Battery Tray allows operation of the **FTA-850L** using six “AA” size alkaline battery cells.

- When installing a cell, insert the (–) end first, then press in the (+) end so the cell snaps into place. Pay attention to the polarity indicated inside the case.

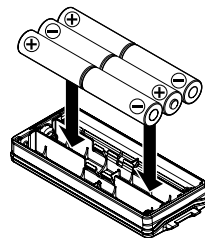

**SBT-12**  
Alkaline Battery Tray







**The SBT-12 must not be used with rechargeable cells. The SBT-12 does not contain the thermal and over-current protection circuits required when utilizing Ni-Cd and Ni-MH cells.**

**Note:** Replace all six cells at the same time in case of low battery.

- ❑ To install the **SBT-12**, turn the open side of the **SBT-12** down, then insert it into the battery compartment.

**Note:** Be sure that the rubber gasket on the SBT-12 is not loose when inserting.

### Battery Life Indication

-  : Full battery power.
-  : Enough battery power.
-  : Low battery power.
-  : Poor battery power. Charge battery
-  : (When Blinking) Charge the battery immediately.

- When the “” icon appears, it is recommended that you charge the battery soon.
- The fully-charged battery lasts for 10 hours on the **FTA-850L** under the conditions below:

**Battery saver ... ON**

**Operation ratio ... TX:RX:Standby = 6:6:48 (sec)**

### External DC Power Supply Connection

You may insert the cable plug of the optional **SDD-12** Cigarette Lighter DC/DC Converter into the **EXT DC** jack located on the right side of the transceiver. In this case, the “” icon will appear in the top right corner of the LCD display.

When making DC connections via the **SDD-12**, be absolutely certain to observe the proper voltage level and polarity guidelines.

- The **SDD-12** can be connected to 12 to 24 Volt DC power sources.

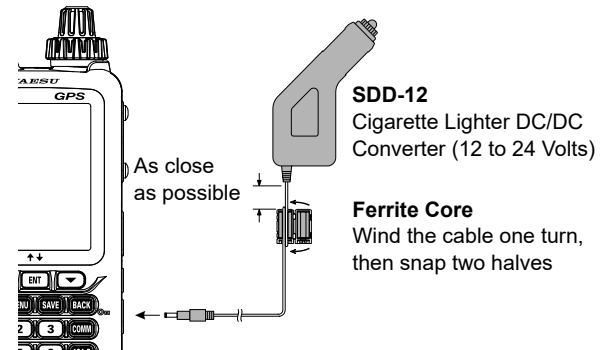

- For noise reduction from exogenous noise, wind one turn of the **SDD-12** cable around the ferrite core, and snap its two halves together, per the illustration above. Attach the ferrite core as close as possible to the **SDD-12** body, as shown.



**Do not connect any accessory unapproved by YAESU to supply DC power; otherwise the FTA-850L may be damaged.**

### Antenna Installation

- To attach the supplied antenna to the **FTA-850L**, grasp the base of the antenna firmly, and exert a moderate “pinching” pressure on the base as you press the antenna onto the radio’s antenna connector. While exerting this pressure, rotate the antenna clockwise 1/4 turn to lock the antenna in place.

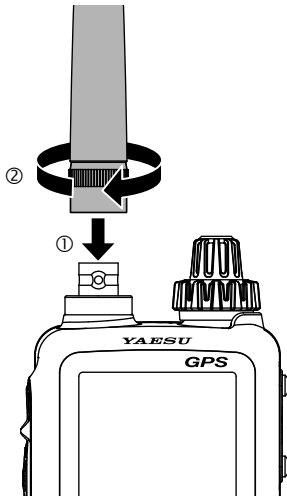

### Belt Clip Installation

You may mount the clip to the rear of the **FTA-850L** using the supplied screws.

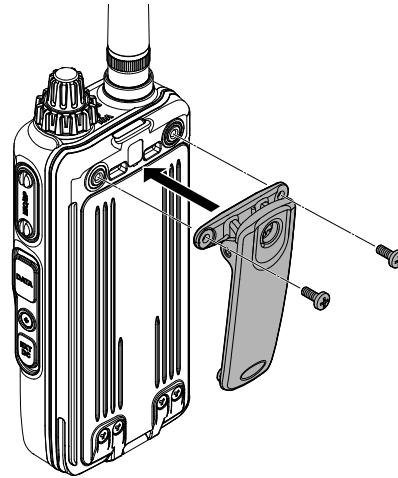

## Headset Connection

You may use an optional headset through the supplied **SCU-42** Headset Adapter Cable.

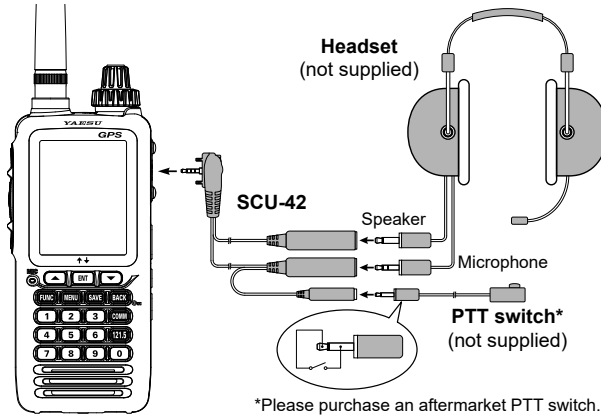

1. Remove the cover and two screws of the **MIC/SP** jack located on the right side of the transceiver.
2. Insert the plug of the **SCU-42** to the **MIC/SP** jack.
3. Fix the plug with two screws attached to the **SCU-42**.
  - Either of the plug directions are acceptable as long as the both screws fit the screw holes.
4. Insert the plugs of the headset to the sockets of the **SCU-42**.

## Precautions

- The **FTA-850L** are capable of two-way communication on channels used for critical aviation safety communications. Therefore, it is important that this radio be kept away from children or other unauthorized users at all times.
- The **FTA-850L** are designed to have the waterproof capability equivalent to IPX5. Do not allow the radio to become submerged, and do not subject it to water spray under pressure.

# BASIC OPERATION

## Reception

### Turning the radio on and off

- ❑ To turn the radio on, press and hold the **POWER** switch. “**WARNING**” will be displayed.

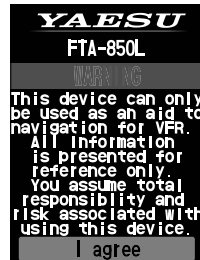
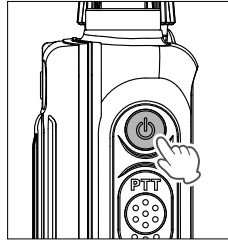

- ❑ If you agree with the warning message, press the [**ENT**] key.

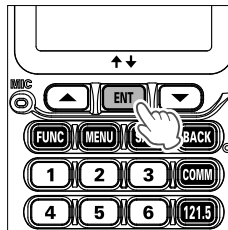

- ❑ A channel frequency will appear on the display. If not, press the [**COMM**] key.

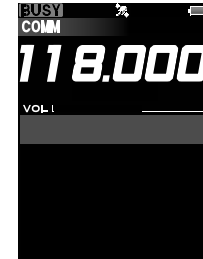
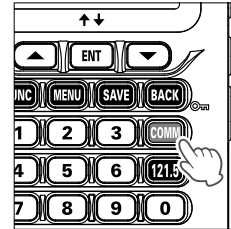

- ❑ The “**BUSY**” icon appears on the display when the audio signal is received on the current frequency.
- ❑ To turn the radio off, press and hold the **POWER** switch.



## Adjusting the frequency

- ❑ You may turn the DIAL (outer) knob on the top panel to choose the desired operating frequency. The channel frequency will appear on the LCD.

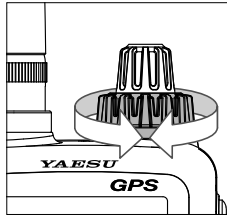

- ❑ Directly entering frequencies from the keypad is the easiest method if you know the frequency on which you wish to operate. Just enter the five digits of the frequency to move to that frequency.



For example, to set 134.35 MHz, press [1] → [3] → [4] → [3] → [5].

To set 118.275 MHz, you do not need to press the final "5" in the frequency as below: press [1] → [1] → [8] → [2] → [7].

- ❑ You may recall the operating frequency that you have used by pressing the [▲] or [▼] key, then press the [ENT] key.

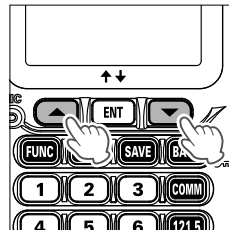

The frequencies used in the past are listed in order on the display.

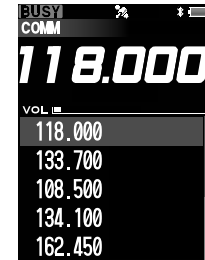

## Adjusting the volume

- ❑ Rotate the **VOL** (inner) knob to set the volume level. If no signal is present, press and hold the **SQL** switch; background noise will now be heard, and you may use this noise to set the **VOL** knob for the desired audio level. Press the **SQL** switch again to eliminate the noise and resume normal (quiet) monitoring.

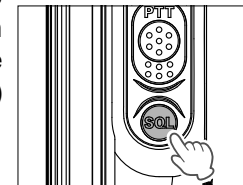
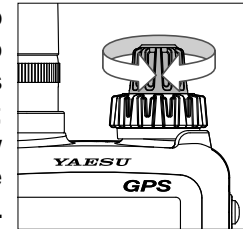

## Adjusting the squelch

- ❑ Press the **SQL** switch, then rotate the DIAL knob to set the squelch threshold so that the receiver is just silenced. The longer the bar graph is displayed that a higher signal level is required in order to open the squelch.

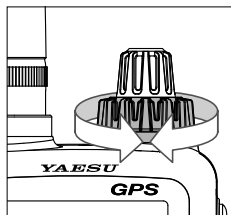
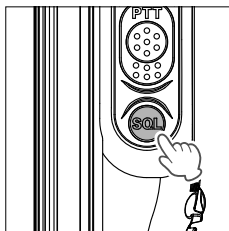

## Monitor Switch

When listening to a very weak signal from an aircraft or ground station, you may observe the signal disappearing periodically as the incoming signal strength becomes too weak to override the squelch threshold setting.

To disable the squelch temporarily, press and hold the **SQL** switch. The squelch will remain open and you should have a better chance of hearing weak signals. To return to normal operation, press the **SQL** switch momentarily.

## Accessing the 121.5 MHz Emergency Frequency

The **FTA-850L** can quickly access the 121.500 MHz emergency frequency. This function can be activated even when the keypad lock function (described on page 28) is in use.

- ❑ To access the emergency frequency, press and hold the [121.5] key. After four beeps, the transceiver enters the emergency mode and the frequency is automatically tuned to 121.500 MHz.
- ❑ To exit the emergency mode, press the [COMM] key. The message confirming the cancellation of the emergency mode will appear. Press the [▲] or [▼] key to select "YES", then press the [ENT] key.

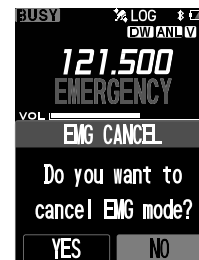
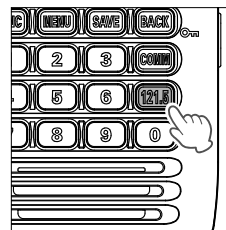

## Transmission (COM Band)

- ❑ To transmit, press and hold the **PTT** switch. Speak into the microphone area of the front panel grille in a normal voice level.

The “**TX**” icon, which indicates that the **FTA-850L** are in the transmit mode, appears on the display.

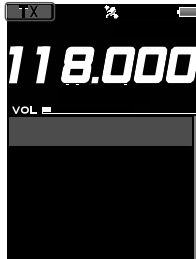
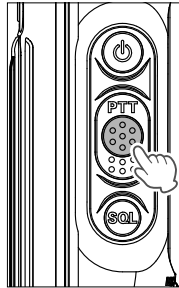

- ❑ To return to the receive mode, release the **PTT** switch.

## Operating Advice: Use of Internal Microphone

Your **FTA-850L** are sealed against water ingress, which includes waterproof seals around the microphone and speaker enclosure. This requires that you focus your speech in the direction of the microphone's location, so as to ensure sufficient voice input to the radio. Refer to the illustration and observe the location of the internal microphone.

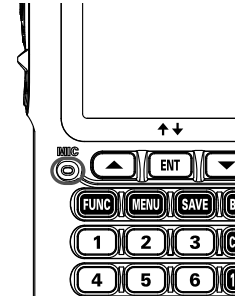

If you find it difficult to utilize the **FTA-850L** conveniently and safely while speaking directly into the microphone, we recommend the use of the **SSM-20A** Speaker/Microphone (option), the **SSM-BT10** Bluetooth® Headset (option), or an aftermarket aviation headset with boom microphone.

## Operation Bands

When the **FTA-850L** are turned on for the first time, it enters the COMM mode and displays the COM band screen. The COMM mode is the basic operation mode of the **FTA-850L** that allows you to tune through either of the NAV and COM bands using the DIAL knob or the keypad.

- **NAV band (108.000 - 117.975 MHz):**  
Band for navigation utilizing data signals emitted by VOR (VHF omnidirectional range) stations and ILS (instrument landing system) of airports.
- **COM band (118.000 - 136.9916 MHz):**  
Band for communication utilizing audio signals.

When the **FTA-850L** receive a data signal associated with VOR or ILS, the display will automatically switch to the NAV band screen which shows a CDI (course deviation indicator) based on the received signal, and “**NAV**”, which indicates that the **FTA-850L** are on the NAV band, appears on the display.



When receiving a VOR signal

## Operation Modes

The **FTA-850L** operate in either of the modes below. You can switch the modes via the MENU screen displayed by pressing the [MENU] key on the front panel.

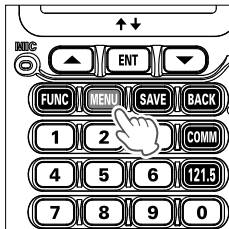

When turning on the **FTA-850L**, the last mode you have used before turning off will automatically be entered.



- **COMM mode**  
The basic operating mode for communication. Navigation through the NAV band is also performed on this mode.
- **DD (Dual Frequency Display) mode**  
In this mode, two channels are displayed at the top and bottom of the screen. Active channels that can be received, transmitted, and operated are displayed in white text. The active channel can be switched instantly by pressing the [▲] / [▼] keys. You can press the [ENT] key to select between three modes of COMM, MEMORY, and WEATHER for the upper or lower channels individually. In MEMORY mode, you can switch memory groups by pressing and holding the [ENT] key.
- **MEMORY mode**  
This mode provides you with the ability to store and recall as many as 400 channels in the radio's main memory bank.

○ **WEATHER** (in USA/Canada Only)

The receive mode for the VHF weather channel broadcasts. 10 weather channels are pre-programmed at the factory.

○ **COMPASS**

The compass with your traveling course up, COG (course over ground), SOG (speed over ground), altitude, and the altitude will be displayed according to the signals received by the built-in GPS unit are displayed.

○ **NAVI**

Navigation to the waypoint (destination) memorized or manually input is carried out in this mode.

○ **TIMER**

You may use the **FTA-850L** as a countdown timer or a stopwatch through this menu.

○ **SETUP**

This mode allows certain aspects of your radio's configuration to be customized for your personal operating conditions.

You can also switch to the SETUP menu screen by press and hold the **[MENU]** key.

## Function Menu

The **FTA-850L** has three function menus, Pressing the **[FUNC]** key displays a menu of frequently used functions in the current mode. You can access the functions just by pressing a number on the numeric keypad of the desired function listed on the display.

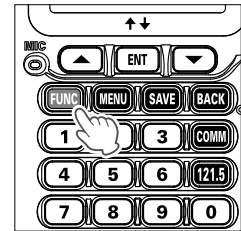

You can also select a function with the **[▲]** / **[▼]** keys or the **DIAL** knob, and then press the **[ENT]** key. Features that are currently unavailable are grayed out.

○ **COMM Func**

The **COMM** Functions such as: COMM, Dual Frequency Display (DD), MEMORY, and WEATHER are displayed by pressing the **[FUNC]** key while in the main modes of the **FTA-850L**.

| COMM Func |            |     |
|-----------|------------|-----|
| 1         | Dual Watch | OFF |
| 2         | Scan       | OFF |
| 3         | Split      | OFF |
| 4         | Logger     | OFF |

○ **NAVI Func**

The **NAVI** Function screen is displayed by pressing the **[FUNC]** key in the navigation mode.

| NAVI Func |             |
|-----------|-------------|
| 1         | Destination |
| 2         | Continue    |
| 3         | Stop        |
| 4         | Back        |

○ **VOR Func**

The **VOR** Function screen is displayed by pressing the **[FUNC]** key while in the VOR CDI mode.

| VOR Func |     |
|----------|-----|
| 1        | OBS |

## Lock Function

This function prevents accidental changes to the frequency setting and the keypad controls.

### ● Setting the lockout configuration

You may choose the controls to be locked.

1. Press and hold the [MENU] key to display the SETUP menu screen.

2. Select “**Config**” on the screen by pressing the [▲] or [▼] key, and then press the [ENT] key.



3. Select “**Lock Select**” on the screen by pressing the [▲] or [▼] key, and then press the [ENT] key.

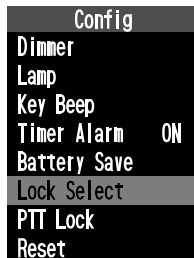

4. Select one of the following lock configuration by pressing the [▲] or [▼] key, and then press the [ENT] key.

**Key Lock / DIAL Lock / All Lock**

The setting will be determined and the display will return to the Config menu.

### ● Activating the lock feature

❑ Press and hold the [BACK] key.

According to the setting of the lockout configuration, either of “**Key Lock**”, “**DIAL Lock**”, or “**All Lock**” will appear on the screen for 2 seconds and then the display will return to the previous screen.

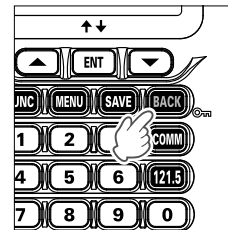

❑ While the **FTA-850L** are locked, the controls with the **VOL** (inner) knob and/or the keys except the **PTT** switch, the **POWER** switch, the **SQL** switch, and the [121.5] key are disabled.

If the DIAL knob is rotated or any of the keys is pressed, either of “**DIAL Lock**”, “**Key Lock**”, or “**All Lock**” will appear on the screen for 2 seconds and then the display will return to the previous screen.

❑ To turn the lock feature off, press and hold the [BACK] key again.

“**UNLOCK**” will appear on the screen for 2 seconds and then the display will return to the previous screen.

## Factory Resetting the Radio

To clear all memories and other settings to factory defaults:

1. Press and hold the [MENU] key to display the SETUP menu screen.
2. Select “**Config**” on the screen by pressing the [▲] or [▼] key, and then press the [ENT] key.
3. Select “**Reset**” on the screen by pressing the [▲] or [▼] key, and then press the [ENT] key.

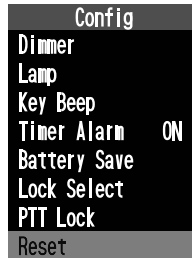

4. Select “**Factory**” on the screen by pressing the [▲] or [▼] key, and then press the [ENT] key.
5. Select “**OK**” on the screen by pressing the [▲] or [▼] key, and then press the [ENT] key.

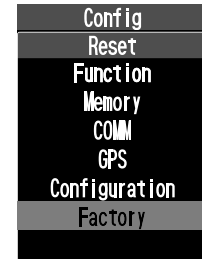

The initialization will start and then “**Complete!**” will be displayed after the radio returns to factory default.

## ADVANCED OPERATION

### DD (Dual Frequency Display)

In DD (Dual Frequency Display) mode, two channels are displayed on the top and bottom of the screen. Only the active channel that is displayed in white letters can be operated in receive and transmit. Set an often-used frequency on the other channel and use the [▲] / [▼] keys to switch instantly between the upper and lower channels.

You can freely select COMM mode, MEMORY mode, and WEATHER CH mode independently on the upper and lower channels.

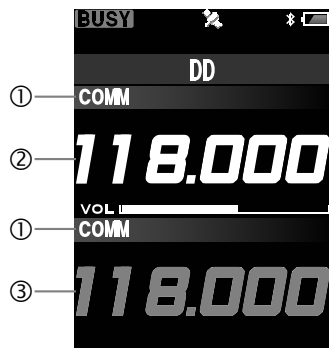

- ① Mode
- ② Active Channel (Displayed in white letters)
- ③ The Inactive Channel (Displayed in gray letters)

1. Press the [MENU] key to display the MENU screen.
2. Select “DD” on the screen by pressing the [▲] or [▼] key, and then press the [ENT] key.

The DD (Dual Frequency Display) screen is shown.



- The mode used before switching to DD mode becomes the active channel in DD mode.
- The display that was previously active in DD mode, becomes the active channel.

#### Notes:

- When DD mode is selected from other modes, the last information of each COMM, MEMORY, and WEATHER CH mode is retained.
- When another mode is selected from DD mode, the last information of each COMM, MEMORY, and WEATHER CH mode of the active channel side of DD mode is retained.



## DD (Dual Frequency Display) mode operation

On the active channel, you can perform most of the usual operations such as receiving and transmitting, changing the frequency, and adjusting the volume. You can also select the active channel with up and down keys, switch the mode, and switch the memory group.

### ● Selecting the active channel

Press the [▲] key to make the top channel the active channel.  
Press the [▼] key to make the lower channel the active channel.

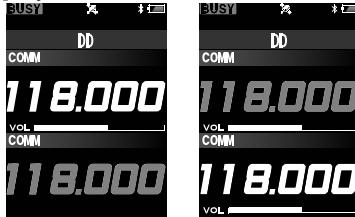

### ● Selecting the mode

Each time you press the [ENT] key, the active channel mode switches as follows:

→ COMM → MEMORY → WEATHER CH → ...

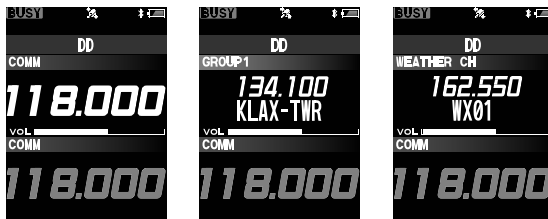

### **Advice:**

As shown in the display example below, you can select the mode individually for the upper and lower channels of the screen.

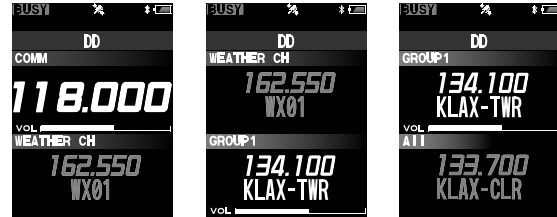

### ● Changing the memory group (MEMORY mode only)

Each time you press and hold the [ENT] key, the memory group of the active channel is switched as shown below:

→ All → GROUP1 → ... → GROUP9 → ...

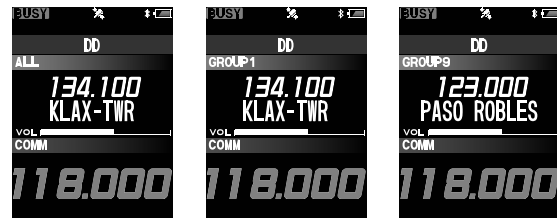

**Note:** Memory groups that do not have any memory channels stored are not displayed.

## Bluetooth® Operation

The FTA-850L has built-in Bluetooth® functionality. Hands-free operation is possible using the optional Bluetooth® headset (SSM-BT10) or a commercially available Bluetooth® headset.

### NOTE:

The operation of all commercially available Bluetooth® headsets cannot be guaranteed.

### Pairing the Bluetooth® Headset

When using the Bluetooth® Headset for the first time, the Bluetooth® Headset and the FTA-850L must be paired.

This step is only necessary when first connecting the headset.

1. To start the Bluetooth® headset in pairing mode.  
**SSM-BT10:** Press and hold the Multi Function Button, until the SSM-BT10 LED blinks red/blue alternately.

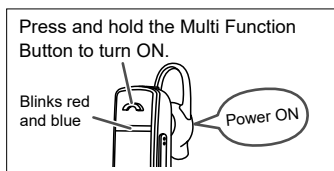

2. Press and hold the [MENU] key to display the SETUP menu screen.

3. Select “Bluetooth” on the screen by pressing the [▲] or [▼] key, and then press the [ENT] key.



4. Press the [ENT] key.

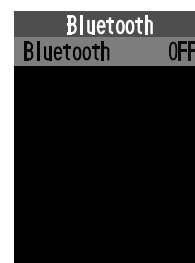

5. Select “ON” on the screen by pressing the [▲] or [▼] key, and then press the [ENT] key.



6. Select “**NEW**” on the screen by pressing the [▲] or [▼] key, and then press the [ENT] key.

The search begins and the model name of the found Bluetooth® device is displayed in the list.

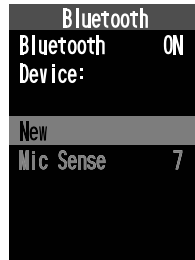

7. Press the [▲] or [▼] key to select the desired Bluetooth® device.



8. Press the [ENT] key. Pairing will start.



- When pairing is complete, “**Connected**” is displayed.
- The LED on the SSM-BT10 blinks blue.
- If the PIN Code entry screen is displayed, enter the PIN code of the Bluetooth® headset and press the [ENT] key.



9. Press the [BACK] key several times to return to normal operation.

While connected to a Bluetooth® headset, the “” icon lights up on the **FTA-850L** screen, and the received audio and operation beep will be heard from the Bluetooth® headset.

#### ● **Bluetooth® headset volume control**

Adjust the volume of the Bluetooth® headset with either the VOL knob on the **FTA-850L** or the volume control operation of the Bluetooth® headset. The volume of the **FTA-850L** can be adjusted individually when the Bluetooth® headset is not connected.

#### ● **Disable the Bluetooth function**

To cancel Bluetooth® operation, just repeat the above procedures, selecting “OFF” in step 5 above.

## ● Subsequent Bluetooth® headset connection when the power is turned ON

- When the power is turned OFF while the Bluetooth® headset is connected, the next time the power is turned ON, the same Bluetooth® headset is searched for and automatically connected when found.
- If the Bluetooth® headset cannot be found, the “” icon flashes on the screen. If the power of the same Bluetooth® headset is turned ON in this state, it will connect automatically. If not, turn the FTA-850L and Bluetooth® headset OFF and then ON again.
- To connect to other Bluetooth® headsets, refer to the “Connect to another paired Bluetooth® headset”.

## Transmit operation by pressing the button on the Bluetooth® headset

Pressing the “Call button”\* on the Bluetooth® headset once will keep the FTA-850L in transmit and a call can be made using the Bluetooth® headset.

Press the “Call button”\* again to return the FTA-850L to receive.

\*The button name may differ depending on your Bluetooth® headset.

**SSM-BT10:** When the Multi Function Key is pressed, a beep will sound and the FTA-850L will continuously transmit.

Press briefly to transmit



Press the Multi Function Key again, a beep will sound and the FTA-850L will return to receive mode.

## Hands-free VOX operation with a Bluetooth® headset

When FTA-850L VOX (automatic voice transmission) function is turned ON, the Bluetooth® headset can perform hands-free operation and transmit automatically just by talking.

Turn the VOX function ON according to “VOX Operation” instruction (page 37).

## Disconnect the connected Bluetooth® headset

1. Press and hold the [MENU] key to display the SETUP menu screen.
2. Select “**Bluetooth**” on the screen by pressing the [▲] or [▼] key, and then press the [ENT] key. The model name of the connected Bluetooth® headset is displayed in the “Device:” area.
3. Select “**Device**” on the screen by pressing the [▲] or [▼] key, and then press the [ENT] key. The device list is Displayed.

| Bluetooth |          |
|-----------|----------|
| Bluetooth | ON       |
| Device:   | SSM-BT10 |
| New       |          |
| Mic Sence | 7        |

4. Press the [▲] / [▼] keys, to select the connected Bluetooth® headset from the list, and press the [ENT] key.



5. Select “Disconnect” on the screen by pressing the [▲] or [▼] key, and then press the [ENT] key. The Bluetooth® headset disconnects.

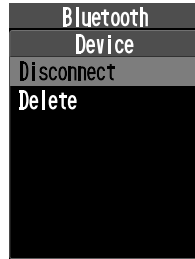

6. Press the [BACK] key

7. Pair with the new Bluetooth® headset by following step 6 of "Pairing the Bluetooth® Headset".

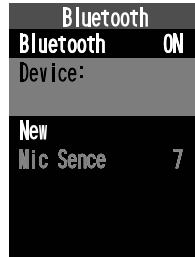

## Connect to another paired Bluetooth® headset

1. Select the Bluetooth® device to be connected in step 4 above, and press the [ENT] key.

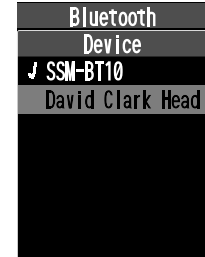

2. Press the [ENT] key. The connection will start. When pairing is complete, “Connected” is displayed.



### ● Remove a registered (paired) Bluetooth® device from the list

1. Select the Bluetooth® device to be deleted in step 4 above, and press the [ENT] key.
2. Select “Delete” on the screen by pressing the [▲] or [▼] key, and then press the [ENT] key. The Bluetooth® headset is removed from the device list.

## ● Adjust the sensitivity of the Bluetooth® microphone

**Note:** This feature is only available if the connected Bluetooth® headset supports it. The optional SSM-BT10 does not support this function.

1. Press and hold the [MENU] key to display the SETUP menu screen.
2. Select “Bluetooth” on the screen by pressing the [▲] or [▼] key, and then press the [ENT] key.
3. Select “Mic Sense” on the screen by pressing the [▲] or [▼] key, and then press the [ENT] key.

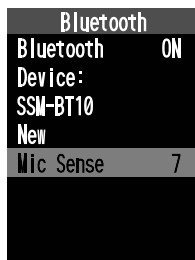

4. Select “ON” on the screen by pressing the [▲] or [▼] key, and then press the [ENT] key.

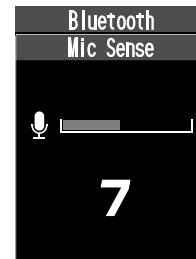

## VOX Operation

*If you want to have both hands free, use a headset and activate the VOX (voice-actuated transmit/receive switching) system.*

### Notes:

- The VOX system does not function when using just the internal microphone; a Bluetooth® headset or an external headset must be used.
- Do not activate the VOX system when connecting the optional microphone **SSM-20A**.
- To activate the VOX system, select “**ON**” on the item “**VOX**” of the COMM Setup menu in the SETUP mode.

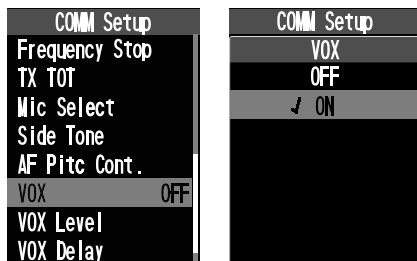

The “**V**” icon, which indicates that the VOX system is active, will appear at the right side of the channel frequency when the display returns to the COM band screen.

- To adjust the VOX gain, select one of the following gain levels on the item “**VOX Level**” of the COMM Setup menu in the SETUP mode.

**MIN / Level1 / Level2 / Level3 / MAX**

- To set the VOX delay, select one of the following times on the item “**VOX Delay**” of the COMM Setup menu in the SETUP mode.

**0.5sec / 1.0sec / 1.5sec / 2.0sec / 3.0sec**

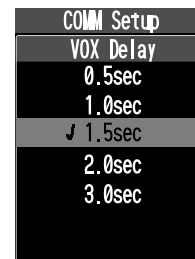

## Reception of VOR Signals

When the **FTA-850L** receive a VOR (VHF omnidirectional range) signal, the display will automatically switch to the VOR screen which shows a CDI (course deviation indicator) based on the received signal, which indicates that the **FTA-850L** are receiving the VOR signal, appears on the display.



- ① Compass rose
- ② Course indicator (OBS direction)
- ③ Deviation marks
- ④ Course deviation needle
- ⑤ OBS (omni bearing selector) value
- ⑥ VOR value
- ⑦ TO/FROM indicator
- ⑧ SOG (speed over ground) value according to the GPS signal

- The OBS is set to 0 degree when you use the **FTA-850L** for the first time.  
The last value you have set as the OBS will be displayed next time the VOR screen appears.
- The upside of the compass rose always indicates the direction set as the OBS.
- When the OBS is set to a degree within the “TO” range relative to the VOR signal, the **FTA-850L** displays a degree adding (or subtracting) 180° to (or from) the VOR signal as the VOR value.

### Note:

You may change the COM band receive frequency while receiving a VOR signal. If the [ENT] key is pressed during the tag name of the VOR station is selected, the recall screen listing the frequencies you have used will temporarily appear on the display, so that you may select a frequency from the list with the [▲] or [▼] key or change the frequency with the DIAL knob.



## ● Reading the CDI

- If the OBS is set to 50° and your aircraft is at 230° from a certain VOR station, for example, you are “on course” and the course deviation needle of the CDI will be at the center of the compass rose.

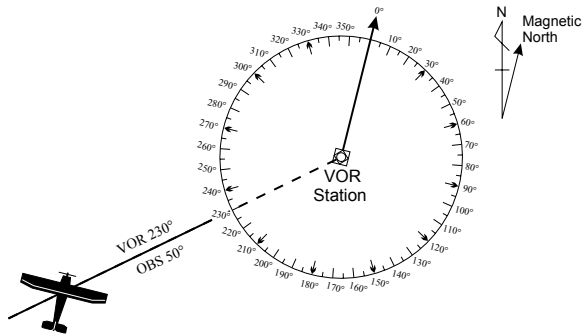

- If the OBS is set to 50° but your aircraft is at 236° from a certain VOR station, for example, you are “off course” and the course deviation needle of the CDI will be inside the right half of the compass rose.

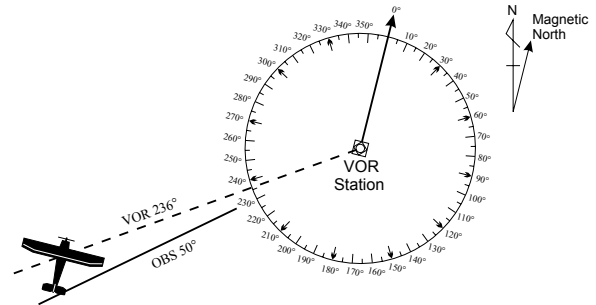

- The course deviation needle moves to the right if your aircraft is off course to the left of the OBS, or moves to the left if your aircraft is off course to the right of the OBS.
- The deviation marks indicate off-course level by 2 degrees up to 10 degrees per each side. If your deviation exceeds 10 degrees, the course deviation needle will stay at the position of the fifth mark (the end of the scale) of the left or right side.

### ● Flying to a VOR station

1. Set the frequency to the desired VOR station.
2. Press the **[FUNC]** key to display the VOR Func menu screen.
3. Press the **[ENT]** key or the **[1]** key.

The OBS (omni bearing selector) on the screen is selected.

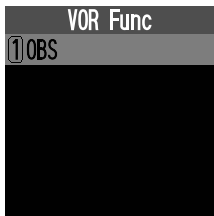

4. Enter the course to the VOR station with the keypad or the DIAL knob.
5. Press the **[ENT]** key again to return to the previous screen.
6. Correct your course until the course deviation needle on the screen is at the center of the compass rose.



### ● Flying to a desired course

If you know the direction of your destination from a specific VOR station, you may use the CDI to correct your course of flying.

1. Set the frequency to the desired VOR station.
2. Press the **[FUNC]** key to display the VOR Func menu screen.
3. Press the **[ENT]** key or the **[1]** key.

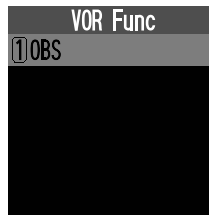

The OBS (omni bearing selector) on the screen is selected.

4. Enter the course from the VOR station with the keypad or the DIAL knob.
5. Press the [ENT] key again to return to the previous screen.
6. Correct your course until the course deviation needle on the screen is at the center of the compass rose.



## Reception of ILS Signals

When the FTA-850L receive an ILS (instrument landing system) signal, the display will automatically switch to the NAV band screen which shows a CDI (course deviation indicator) based on the received signal, and “LOC” and/or “GS”, which indicates that the FTA-850L are receiving the localizer signal and/or glide slope signal.

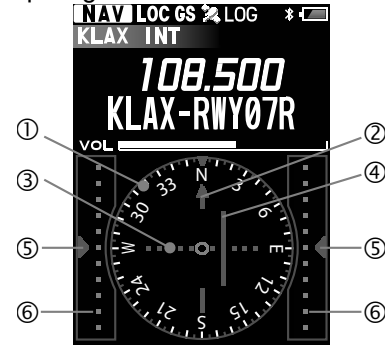

- ① Compass rose
- ② Course (runway) indicator
- ③ Deviation marks for localizer
- ④ Course deviation needle for localizer
- ⑤ Height deviation indicator for glide slope
- ⑥ Deviation marks for glide slope

- When the internal GPS unit is not activated or cannot receive a fix even it is activated, the upside of the compass rose always indicates the direction of the runway and no sign indicating the bearings is displayed on the compass rose.
- When the internal GPS unit is activated and receives a fix, the compass rose rotates to display the approaching course up.



Without GPS



With GPS, no GS signal

**Note:**

You may change the COM band receive frequency while receiving an ILS signal. If the [ENT] key is pressed while the tag name of the airport is selected, the recall screen listing the frequencies you have used will temporarily appear on the display, so that you may select a frequency from the list with the [▲] or [▼] key or change the frequency with the DIAL knob.

**Terminology:**

- The localizer signal guides the approach to the runway in horizontal direction.
- The glide slope signal guides the approach to the runway in vertical direction. Note that some airports are unequipped with the glide slope.

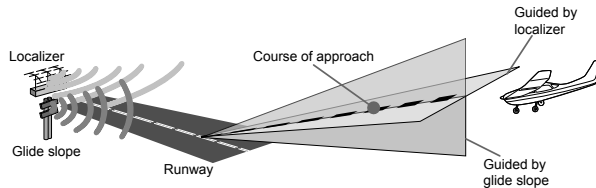

## ● Reading the CDI

- The course deviation needle moves to the right if your aircraft is off course to the left of the runway, or moves to the left if your aircraft is off course to the right of the runway.
- The height deviation indicator moves up if your aircraft flies lower than the ideal altitude, or moves down if your aircraft flies higher than the ideal altitude.

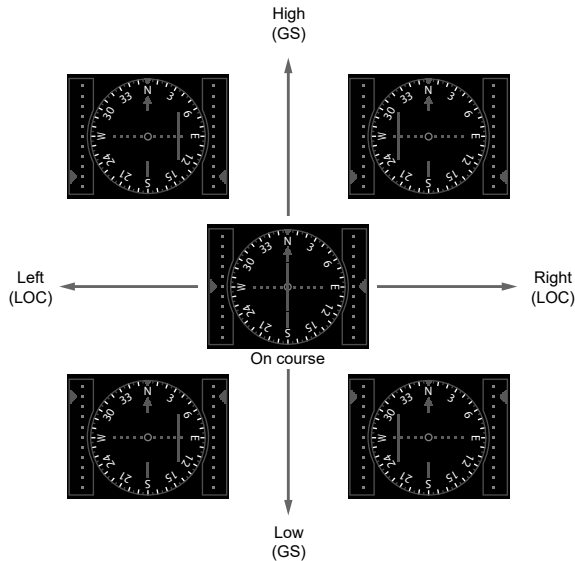

**CDI Examples Corresponding to Aircraft Location**  
(Runway is to be at the back of the screen)

## Split Operation

The split operation feature allows you to transmit a call to a flight service station using the COM band frequencies, while receiving a station in the NAV band. VOR stations equipped with this capability typically are shown, on navigation charts, with the voice calling frequency in parenthesis above the navigation frequency.

### ● Programming a transmit frequency

1. Press and hold the [MENU] key to display the SETUP menu screen.
2. Select “**COMM Setup**” on the screen by pressing the [▲] or [▼] key, and then press the [ENT] key.
3. Select “**Split Frequency**” on the screen by pressing the [▲] or [▼] key, and then press the [ENT] key.

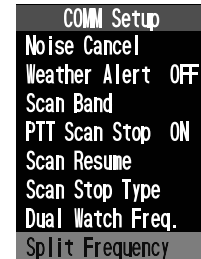
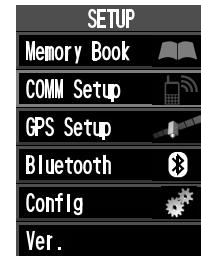

4. Enter the transmit frequency with the keypad.

**Note:**

Only the COM band frequencies (118.000 - 136.9916 MHz) can be set as the transmit frequency.

5. Select “**FINISH**” on the screen by pressing the [▲] or [▼] key, and then press the [ENT] key.

The frequency will be determined and the display will return to the COMM Setup menu.



● **Activating the split mode**

1. Press the [FUNC] key to display the COMM Func menu screen.
2. Select “**Split**” on the screen by pressing the [▲] or [▼] key, and then press the [ENT] key.  
The same operation as above is possible by pressing the [3] key.

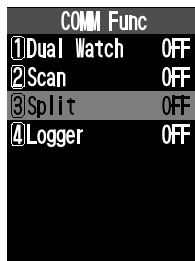

- If “**ON**” is displayed in the right hand of “**Split**”, the **FTA-850L** are already in the split mode.

The display will return to the previous screen and the “±” icon, which indicates that the **FTA-850L** are in the split mode, will appear on the display.



● **Operating in the split mode**

- To transmit a voice call during the NAV band reception, press and hold the **PTT** switch, and speak into the microphone. The COM band screen will be displayed with the frequency you have set.
- To exit the split mode, press the [ENT] key again in step 2 above.

## Reception of Weather Channel Broadcasts

### (In USA/ Canada only)

The **FTA-850L** can receive VHF weather channel broadcasts, which may assist your flight planning. The **FTA-850L** include a special bank capable of storing 10 weather channels, which simplifies access when you are in an unfamiliar location.

- ❑ To receive weather channels, press the **[MENU]** key, select “**WEATHER**” on the screen by pressing the **[▲]** or **[▼]** key, and then press the **[ENT]** key.



The last channel you have tuned will be received.

- ❑ You can also select a weather channel from the pre-programmed list with the DIAL knob. To confirm the weather channel frequency selection, press the **[ENT]** key.
- ❑ To exit the WX mode, press the **[MENU]** key, select the mode other than “**WEATHER**” on the screen by pressing the **[▲]** or **[▼]** key, and then press the **[ENT]** key.

## ● Weather alert reception

In the event of extreme weather disturbances, such as storms and hurricanes, the NOAA (National Oceanic and Atmospheric Administration) sends a weather alert accompanied by a 1050 Hz tone and subsequent weather report on one of the NOAA weather channels. When the radio receives the weather alert on the operating frequency, it displays a warning as below on the screen and continues to make alarm sounds until either of the keys is pressed.



You may enable or disable the alarm function when receiving the weather alert signal via the COMM Setup menu, if desired. See page 76 for details.

## Dual Watch Operation

The dual watch feature automatically checks for activity on the dual watch frequency (priority channel) set via the COMM Setup menu while you are operating on another channel. During the dual watch operation, the current channel and the dual watch frequency will be polled alternately.

### ● Setting the priority channel

1. Press and hold the [MENU] key to display the SETUP menu screen.
2. Select “**COMM Setup**” on the screen by pressing the [▲] or [▼] key, and then press the [ENT] key.



3. Select “**Dual Watch Freq.**” on the screen by pressing the [▲] or [▼] key, and then press the [ENT] key.

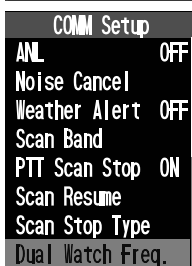

4. Enter the frequency you want to poll, with the keypad.

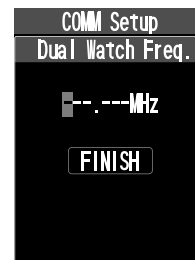

5. Select “**FINISH**” on the screen by pressing the [▲] or [▼] key, and then press the [ENT] key.

The frequency will be determined and the display will return to the COMM Setup menu.

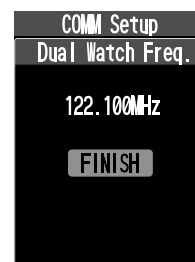

### ● Starting the dual watch

1. Press the [FUNC] key to display the COMM Func menu screen.
2. Select “**Dual Watch**” on the screen by pressing the [▲] or [▼] key, and then press the [ENT] key.

The same operation as above is possible by pressing the [1] key.

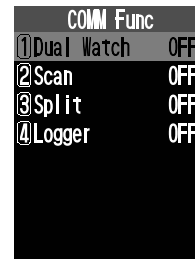



- If “**ON**” is displayed in the right hand of “**Dual Watch**”, the **FTA-850L** are performing the dual watch.

The display will return to the previous screen and the “**DW**” icon, which indicates that the **FTA-850L** are performing the dual watch, will appear on the display.

- ❑ When the radio encounters a signal in the current channel, it still polls both channels alternately with longer staying time on the current channel.
- ❑ When the radio encounters a signal in the priority channel, the radio stays on the priority channel until the signal disappears, and the frequency indication on the display blinks.  
After the signal disappears, the dual watch resumes.
- ❑ To stop the dual watch, select “**Dual Watch**” and press the [ENT] key in the COMM Func menu.

## TOT Feature

The TOT (time-out timer) shuts off the transceiver after continuous transmission exceeds the programmed time. This feature prevents unintended transmission by mistake and reduces battery consumption.

To select the TOT, select either of “**1min**”, “**2min**”, “**3min**”, “**4min**”, “**5min**” on the item “**TX TOT**” of the COMM Setup menu in the SETUP mode.

| COMM Setup       |
|------------------|
| Scan Band        |
| PTT Scan Stop ON |
| Scan Resume      |
| Scan Stop Type   |
| Dual Watch Freq. |
| Split Frequency  |
| Frequency Step   |
| TX TOT           |

| COMM Setup |
|------------|
| TX TOT     |
| 1min       |
| 2min       |
| 3min       |
| 4min       |
| ↓ 5min     |

## Saving the Battery during Reception

One of the important features of the **FTA-850L** are its battery saver, which “puts the radio to sleep” for a time interval, periodically “waking it up” to check for activity. If somebody is talking on the channel, the **FTA-850L** will remain in the “awake” mode, then resume its “sleep” cycles. This feature significantly reduces quiescent battery drain.

To activate the battery saver, select one of the following interval time ratios on the item “**Battery Save**” of the Config menu in the SETUP mode.

- 50%** ... Sleeps for 100 ms after 100 ms awake
- 70%** ... Sleeps for 250 ms after 100 ms awake
- 80%** ... Sleeps for 450 ms after 100 ms awake
- 90%** ... Sleeps for 900 ms after 100 ms awake

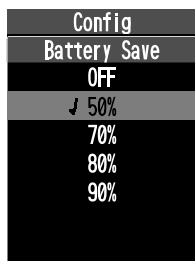
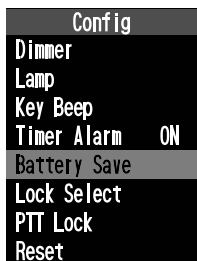

## Using the Headset Microphone

If you want to use the microphone of an aviation headset prepared by yourself, change the assignment of microphone controlled with the **PTT** switch.

**To assign the headset microphone, select “EXT Mic” on the item “Mic Select” of the COMM Setup menu in the SETUP mode.**

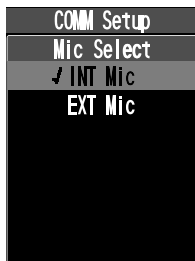
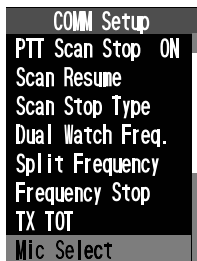

When an optional aviation headset is connected, the **PTT** switch on the radio will activate the headset microphone for transmission.

### Note:

If you find it difficult to use the PTT switch of the radio, we recommend to use an aftermarket external PTT switch. See page 89 for details.

## Side Tone Control

When utilizing an external headset, you may monitor your own voice talking to the microphone through the headphone.

### Note:

Do not activate the side tone function when connecting the optional microphone **SSM-20A**.

- To activate the monitoring of your voice (side tone), select one of the following side tone level on the item “**Side Tone**” of the COMM Setup menu in the SETUP mode.

**OFF / MIN / Level1 / Level2 / MAX**

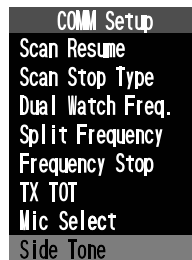

- To change the side tone level temporarily during the monitoring, rotate the DIAL knob when pressing and holding the **PTT** switch.

## Changing the Channel Steps

The synthesizer of the **FTA-850L** provides the option of utilizing channel steps of 8.33/25 kHz per step.

The **FTA-850L** are set up with default channel steps of 25 kHz (NAV and COM bands). If you need to change the channel step increments, select “**8.33kHz**” on the item “**FREQUENCY STEP**” of the COMM Setup menu in the SETUP mode.

### Notes:

- The 8.33 kHz steps are available in the COM Band only.
- When you set the channel step to 8.33 kHz, the channel display differs from actual operating frequency; see the chart below. However, the operator (pilot, tower, control, etc.) will call out the frequency according to what the display indicates.

| Operating Frequency | Display       |             |
|---------------------|---------------|-------------|
|                     | 8.33 kHz Step | 25 kHz Step |
| 1xx.0000 MHz        | 1xx.005       | 1xx.000     |
| 1xx.0083 MHz        | 1xx.010       |             |
| 1xx.0166 MHz        | 1xx.015       |             |
| 1xx.0250 MHz        | 1xx.030       | 1xx.025     |
| 1xx.0333 MHz        | 1xx.035       |             |
| 1xx.0416 MHz        | 1xx.040       |             |
| 1xx.0500 MHz        | 1xx.055       | 1xx.050     |
| 1xx.0583 MHz        | 1xx.060       |             |
| 1xx.0666 MHz        | 1xx.065       |             |
| 1xx.0750 MHz        | 1xx.080       | 1xx.075     |
| 1xx.0833 MHz        | 1xx.085       |             |
| 1xx.0916 MHz        | 1xx.090       |             |

- The adjacent channel selectivity will be slightly degraded while receiving using 8.33 kHz channel .

## ANL Feature

For reduction of impulse noise, such as that produced by an engine’s ignition system, the ANL (Automatic Noise Limiter) feature may prove helpful.

To activate the ANL, select “**ON**” on the item “**ANL**” of the COMM Setup menu in the SETUP mode.

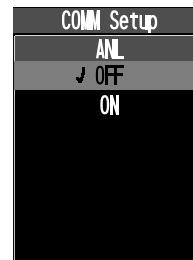
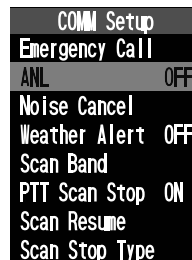

## Compass display

1. Press the [MENU] key to display the MENU screen.
2. Select “COMPASS” on the screen by pressing the [▲] or [▼] key, and then press the [ENT] key.



The compass with your traveling course up, COG (course over ground), SOG (speed over ground), altitude, and the date will be displayed.



### Note:

The power save operation of the GPS unit is disabled while displaying the position information.

## PTT Lock Function

This function prevents accidental transmissions by locking or disabling the PTT switch. You may select enable or disable the PTT lock function for internal PTT, external PTT, or both.

1. Press and hold the [MENU] key to display the SETUP menu screen.
2. Select “Config” on the screen by pressing the [▲] or [▼] key, and then press the [ENT] key.
3. Select “PTT Lock” on the screen by pressing the [▲] or [▼] key, and then press the [ENT] key.
4. Select one of the following PTT lock configuration by pressing the [▲] or [▼] key, and then press the [ENT] key.

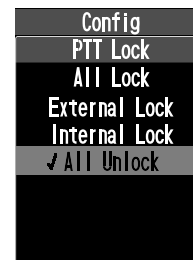

## MEMORY OPERATION

The **FTA-850L** provide 400 user-programmable memories which can hold sets of information about channels such as its channel frequency, position information, channel tag (name) up to 14 characters, and flag (marking for search refinement).

The stored channels can be assigned to GROUP1-GROUP9, which can be named with up to 10 characters.

The **FTA-850L**'s memory system allows you to store, label, and recall channel frequencies you may use frequently.

### Recalling the Memories

1. Press the [**MENU**] key to display the MENU screen.
2. Select “**MEMORY**” on the screen by pressing the [**▲**] or [**▼**] key, and then press the [**ENT**] key.

The last recalled group will be displayed on the screen.

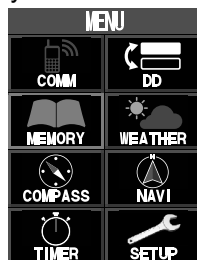

3. Press and hold the [**ENT**] key to select the desired memory group.

→ **All** → **GROUP1** → ...  
→ **GROUP9** → **All** →

**Note:** Groups that have not been stored are not displayed.

- The memory channels belong to either of the following groups.

**All ...** Group including all the memory channels.  
**GROUP1 to GROUP9...**

Groups of memory channels that you can set “GROUP1” to “GROUP9” when storing.

4. You may tune to one of the memory channel in the list by pressing the [**▲**] or [**▼**] key, by rotating DIAL knob. Press and hold the [**SAVE**] key to display the information stored in the memory channel.



**Note:** Memory channels that do not store frequency information are not displayed.

- To return to the COMM mode, press the [**COMM**] key.

## Instant Storage

- ❑ Select a desired frequency in the COMM mode, then press and hold the [SAVE] key.

The MEMORY BOOK form appears on the display, with the channel name (tag), frequency, group (GROUP1), scan and position information (if exists) already filled.

- ❑ To save the memory with this information, press the [SAVE] key.

### Note:

The memory channel in which the position information is entered can be used as a destination in the navigation function.

- ❑ If you want to customize the information to be stored, refer to the procedure below.
  1. Press the [▲] or [▼] key to select the item, then press the [ENT] key.
  2. Input letters and/or numerics with the keypad or the DIAL knob, or select a setting with the [▲] or [▼] key, then press the [ENT] key.

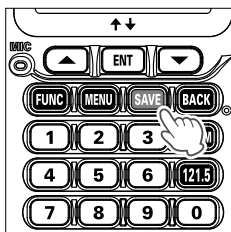

3. After all the inputs or changes have been done, press the [SAVE] key, or select "SAVE" at the bottom of the display with the [▲] or [▼] key, then press the [ENT] key to store them into the memory.

- ❑ Press the [BACK] key to cancel the changes or inputs.

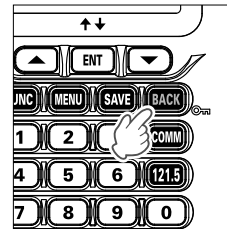

### Note:

You cannot store weather channels to the memory by pressing the [SAVE] key during the WX mode.

## Maintenance of the Memory

Adding new addresses, editing the stored information, and deleting the stored addresses are allowed through the SETUP mode.

### ● Adding entries

1. Press and hold the [MENU] key to display the SETUP menu screen.

2. Select “**Memory Book**” on the screen by pressing the [▲] or [▼] key, and then press the [ENT] key.



3. Select “**New**” by pressing the [▲] or [▼] key, and then press the [ENT] key.



4. Select “**Memory CH**” by pressing the [▲] or [▼] key, and then press the [ENT] key.

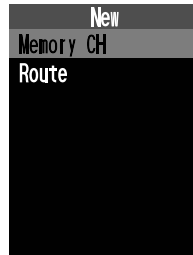

**Note:**

You may select “**Route**” to create a new route for navigation. See page 64 for details.

5. Select the item, input letters and/or numerics, select a setting, and store the changes in the same way as the instant storage described previously.

**Notes:**

- You cannot skip the input of “**Name**” (channel tag).
- You must input either of “**Freq.**” (channel frequency) or “**Lat**” and “**Lon**” (position information of the channel).

● **Editing the information**

1. Press and hold the [MENU] key to display the SETUP menu screen.
2. Select “**Memory Book**” on the screen by pressing the [▲] or [▼] key, and then press the [ENT] key.
3. Select “**Edit**” by pressing the [▲] or [▼] key, and then press the [ENT] key.

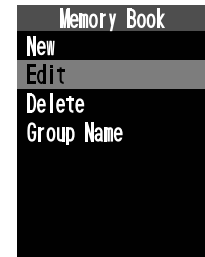

4. Press the [▲] or [▼] key to select the group including the entry you want to edit, then press the [ENT] key.
5. Press the [▲] or [▼] key to select the entry you want to edit, then press the [ENT] key.
6. Select the item, input letters and/or numerics, select a setting, and then store the changes in the same way as the instant storage described previously.

### Note:

You may select a memory of the route to edit a route for navigation. See page 67 for details.

#### ● Deleting the memory

1. Press and hold the [MENU] key to display the SETUP menu screen.
2. Select “**Memory Book**” on the screen by pressing the [▲] or [▼] key, and then press the [ENT] key.
3. Select “**Delete**” by pressing the [▲] or [▼] key, and then press the [ENT] key.



4. Press the [▲] or [▼] key to select the group including the entry you want to delete, then press the [ENT] key.
5. Press the [▲] or [▼] key to select the entry you want to delete, and then press the [ENT] key.
6. Select “**OK**” on the screen by pressing the [▲] or [▼] key, and then press the [ENT] key.

The display will return to the previous screen after the deletion of the entry from the memory.

#### ● Setting the group name

1. Press and hold the [MENU] key to display the SETUP menu screen.
2. Select “**Memory Book**” on the screen by pressing the [▲] or [▼] key, and then press the [ENT] key.
3. Select “**Group Name**” by pressing the [▲] or [▼] key, and then press the [ENT] key.



4. Press the [▲] or [▼] key to select the group including the entry you want to change, and then press the [ENT] key.
5. Use the DIAL knob to edit the letters and/or numerics of the group name, then press the [ENT] key. The cursor will move to the next digit of the group name.
6. Select “**FINISH**” by pressing the [▲] or [▼] key, and then press the [ENT] key.



## SCANNING OPERATION

The **FTA-850L** allow you to scan active channels automatically in the COMM (COM & NAV band), and MEMORY CH modes. It pauses on signals encountered, so you can talk to the station(s) on that frequency if you like.

### Scanning Channels

1. Set the radio to the COMM mode.
2. Press the [**FUNC**] key to display the COMM Func menu screen.
3. Select "**Scan**" on the screen by pressing the [**▲**] or [**▼**] key, and then press the [**ENT**] key.  
The same operation as above is possible by pressing the [**2**] key.

| COMM Func    |     |
|--------------|-----|
| ① Dual Watch | OFF |
| ② Scan       | OFF |
| ③ Split      | OFF |
| ④ Logger     | OFF |

The scanning starts and the display returns to the COMM mode screen.

- ❑ The scanner searches signals from the lower frequency to higher. If the DIAL knob is rotated while scanning is in progress, the scanning will continue up or down in frequency according to the direction of the DIAL knob rotation.

- ❑ When the scanner encounters a signal, the scanning pauses and the frequency indication on the display blinks, and the radio remains on that channel until the signal disappears.
- ❑ If the transceiver is turned OFF while scanning, when the transceiver is turned ON, scanning will resume.
- ❑ To stop the scanning, press the **PTT** switch, or select "**SCAN**" again in the COMM Func menu.

| COMM Func    |     |
|--------------|-----|
| ① Dual Watch | OFF |
| ② Scan       | ON  |
| ③ Split      | OFF |
| ④ Logger     | OFF |

Next time the scanning is activated, the search will start from the frequency at which the scanning was stopped last time.

#### Note:

When you enable the alarm function at reception of the weather alert signal via the COMM Setup menu in the SETUP mode, the last weather channel will be watched as the every second frequency during a scan.

*Example:* When the last weather channel is **WX03**, the radio scans in the following order.

108.000 → **WX03** → 108.025 → **WX03** →  
108.050 → **WX03** ...

The frequency of the last weather channel, however, will not be displayed until the scanner encounters the weather alert signal.

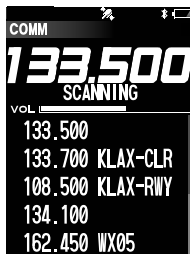

### Selecting Scanning Band

“ALL BAND” scans both the COM and NAV bands between 108.000MHz and 136.9916MHz. “COM BAND” scans the COM band between 118.000MHz and 136.9916MHz. “NAV BAND” scans the NAV band between 108.000MHz and 117.975MHz.

1. Press and hold the [MENU] key to display the SETUP menu screen.
2. Select “**COMM Setup**” on the screen by pressing the [▲] or [▼] key, and then press the [ENT] key.
3. Select “**Scan Band**” on the screen by pressing the [▲] or [▼] key, and then press the [ENT] key.

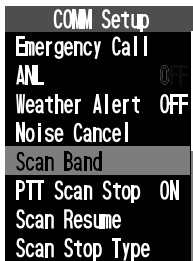

4. Select the desired scan operation by pressing the [▲] or [▼] key, and then press the [ENT] key.

**ALL Band (108 - 137 MHz) /  
COMM Band (118 - 137 MHz)  
/NAVI Band (108 - 118 MHz)**

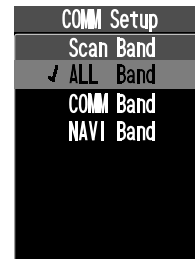

The setting will be determined and the display will return to the COMM Setup menu.

### Scanning the Memory Channels

Among the memory, you may scan only those on which you want to see if a signal exists.

#### ● Marking the channels

1. Press and hold the [MENU] key to display the SETUP menu screen.
2. Select “**Memory Book**” on the screen by pressing the [▲] or [▼] key, and then press the [ENT] key.
3. Select “**EDIT**” by pressing the [▲] or [▼] key, and then press the [ENT] key.
4. Press the [▲] or [▼] key to select the group including the entry you want to edit, then press the [ENT] key.
5. Press the [▲] or [▼] key to select the entry you want to edit, then press the [ENT] key.

- Press the [▲] or [▼] key to select “SCAN” then press the [ENT] key.

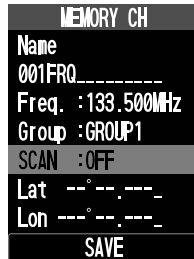

- Press the [▲] or [▼] key to select the “ON” then press the [ENT] key.
- After all the inputs or changes have been done, press the [SAVE] key, or select “SAVE” at the bottom of the display with the [▲] or [▼] key, then press the [ENT] key to store them into the memory.

The current channel is marked to be scanned and the “MEM” icon, which indicates that the channel is the target of scanning, will appear at the right side of the channel frequency when the display returns to the MEMORY mode screen.



- Repeat steps 5 to 8 above to mark other channels as well.

### ● Scanning the memory channels

- Set the radio to the MEMORY mode, then perform steps 2 to 4 of the section “Marking the channels” in the page 56.

- Set the radio to the MEMORY mode.
- Press the [FUNC] key to display the COMM Func menu screen.
- Select “Scan” on the screen by pressing the [▲] or [▼] key, and then press the [ENT] key.

The same operation as above is possible by pressing the [2] key.

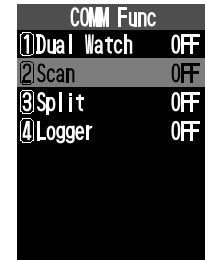

The scanning starts and the display returns to the MEMORY mode screen.

### Note:

When you enable the alarm function at reception of the weather alert signal via the COMM Setup menu in the SETUP menu mode, the last weather channel will be watched as the every second channel during a scan.

*Example:* when the last weather channel is WX03, the radio scans in the following order.

MEM001 → **WX03** → MEM002 → **WX03** → MEM003 → **WX03** ...

The frequency of the last weather channel, however, will not be displayed until the scanner encounters the weather alert signal.

## NAVIGATION

The navigation function of the **FTA-850L** is displayed on the compass screen, which allows checking the destination direction and direction of travel at a glance. The destination or route can be selected from pre-saved memory or previously used history, or you can enter a new latitude and longitude to set it as the destination. During route navigation, you can check the section currently in flight, the next waypoint, and the entire route on the easy-to-understand route display screen.

### Notes:

- Be sure that the internal GPS unit has been activated before using the navigation.
- The navigation does not work when insufficient number of GPS satellites are captured to obtain your position.

## Starting Navigation

1. Press the **[MENU]** key to display the MENU screen.

2. Select **"NAVI"** on the screen by pressing the **[▲]** or **[▼]** key, and then press the **[ENT]** key.

The screen for selecting the destination is displayed.



## Select the destination or the route

There are three ways to select a destination or route:

- Select a destination or route from memory**  
Select the stored memory (including latitude and longitude information) or route to start navigation.
- Select a destination or route from the history**  
Start navigation by selecting from the memory or route history previously used for navigation.
- Enter latitude and longitude directly to set the destination**  
Enter a new latitude and longitude to start navigating to that point.

- **Select a destination or route from memory**

1. Press the **[▲]** / **[▼]** keys to select **"Memory"** and press the **[ENT]** key.



2. Press the [▲] / [▼] keys to select the group in which the desired memory is saved, and then press the [ENT] key.

All memory channels are displayed in the “All” group.

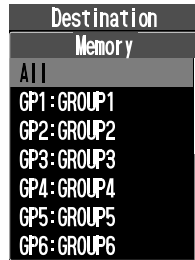

3. Press the [▲] / [▼] keys to select waypoint or route and then press the [ENT] key.

- Waypoints appear at the top of the list, followed by routes.
- “TO” is displayed before the name of the route memory.
- Only the memory where the latitude / longitude information is stored is displayed.



- **When a waypoint is selected**

A confirmation screen for the latitude and longitude of the waypoint to be set as the destination is displayed.

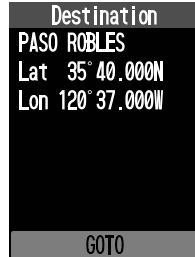

- **When a route is selected**

The route confirmation screen is displayed. Waypoints registered in route order are displayed from bottom to top.

- ⊙ : Destination
- : Waypoint
- ▲ : Origin

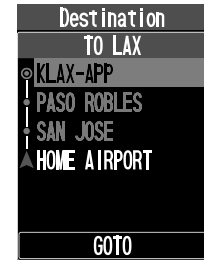

### Display the latitude and longitude of waypoints on the route confirmation screen

If you select a route, press the [▲] / [▼] keys to select a waypoint and press the [ENT] key to display the latitude and longitude of that point. Press the [ENT] key or the [BACK] key again to return to the original screen.

4. Follow the steps below to start navigation.

#### When a waypoint is selected:

Press the [ENT] key to display the compass screen and start waypoint navigation from your current location.

#### When a route is selected:

Press the [▲] / [▼] keys to select “GOTO” and press the [ENT] key to display the compass screen and start route navigation.

## Navigation screen



- ① Compass rose
- ② Course indicator
- ③ Waypoint indicator
- ④ Tag name of the next waypoint or destination
- ⑤ DST (distance)
- ⑥ COG (course over ground)
- ⑦ SOG (speed over ground)
- ⑧ ALT (altitude)

- The compass rose rotates to display the travelling course up.
- Upon arriving at the destination, a bell will sound, the navigation will end, and the compass screen will continue to display.
- For route navigation, when arriving at a waypoint, a beep will sound and the next waypoint will automatically be displayed.
- On the navigation screen, the frequency or memory channel may be changed by turning the **DAIL** knob.

- If the [ENT] key is pressed during navigation, the flip-flop in COMM mode or the memory list in COMM mode will be displayed temporarily while the navigation continues. Flip-flops or memory channels may be selected by pressing the [▲] / [▼] keys. About 15 seconds after pressing the [BACK] key, or stopping the operation, the navigation screen will be returned.

### Notes:

- Waypoints and destination distances can be set in the GPS Setup "**Arrival Range**" (see page 83).
- When "**RECALLGPS + F**" (see page 80) of GPS Setup is set to "**ON**", the transceiver frequency is automatically saved in the next waypoint where the frequency information is saved. It will be changed to the frequency you are using.

### ● Select a destination or route from the history

Start navigation by selecting from the memory or route history previously used for navigation.

1. Press the [▲] / [▼] keys to select "**History**" and press the [ENT] key.  
Waypoints appear at the top of the list, followed by routes.



2. Select the destination or route and start the navigation by the same operation as steps 2 to 4 of “**Select the destination or the route**”.



● **Enter latitude and longitude directly to set the destination**

1. Press the [▲] / [▼] keys to select “New” and press the [ENT] key.



2. Press the [▲] or [▼] key to select the “Lat / Lon” item, and press the [ENT] key.

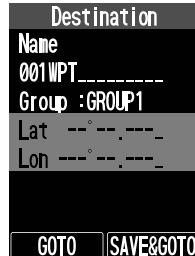

3. Press the keypad or select a number or letter with the DIAL knob and press the [ENT] key.
4. Repeat step 3 and enter all the location information.



To correct a typo, press the [▲] or [▼] key to move the cursor to the digit to change, and then repeat step 3.

5. Press the [▲] / [▼] keys to select “FINISH” and press the [ENT] key. The entered information is displayed.

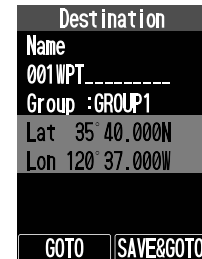

6. Press the [▲] / [▼] keys to select “GOTO” and press the [ENT] key.
  - The compass screen will appear and start waypoint navigation from your current location.



- If “**SAVE & GOTO**” is selected in step 6 above, the input latitude / longitude information will be stored in the memory, and then the waypoint navigation will start with the memory stored from the current location as the destination.
- The “**Name**” (tag name) and group may be changed and saved in the same way as writing to memory.

### Route display during navigation

On the route screen, you can check the section you are currently flying and the next waypoint.

1. Press the [FUNC] key to display the NAVI Func screen.

2. Press the [▲] / [▼] keys to select “**Continue**” and press the [ENT] key.

The same operation as above is possible by pressing the [2] key.



### Route display screen

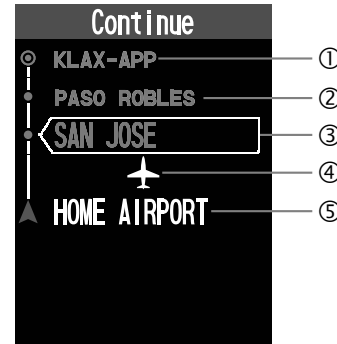

- ① Destination
- ② Waypoint
- ③ Next Waypoint
- ④ Current position
- ⑤ Origin

- When arriving at a waypoint, the screen refreshes to show the section you are currently position and the next waypoint.
- If the entire route is not displayed, press the [▲] or [▼] key or turn the DIAL knob to scroll the screen to display it.
- Press the [BACK] key twice to return to the navigation screen.



## Stopping navigation in progress

1. Press the [FUNC] key to display the NAVI Func screen.
2. Press the [▲] / [▼] keys to select “**Stop**” and then press the [ENT] key.  
The same operation as above is possible by pressing the [3] key.



3. A confirmation screen will be displayed. To end navigation, press the [ENT] key.  
Stop the navigation and display the compass screen.



## Back to departure point

You can easily return to the starting point during navigation. If you are in the process of route navigation, the reverse route navigation will be started and you will be able to return to the waypoints you have passed from the starting point (Origin) in the reverse order.

1. Press the [FUNC] key to display the NAVI Func screen.
2. Press the [▲] / [▼] keys to select “**Back**” and press the [ENT] key.  
The same operation as above is possible by pressing the [4] key.
3. A confirmation screen will be displayed. To return to the starting point, press the [ENT] key. Navigation to the starting point begins.

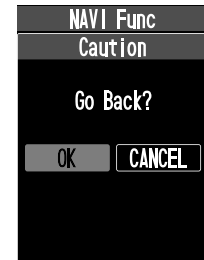

### **Note:**

- In the case of waypoint navigation, the destination is the starting point of latitude and longitude saved by GPS when the navigation is started.
- If GPS is not positioned and latitude / longitude cannot be saved, an error alarm will sound and navigation to the departure point cannot be started.

## Start a new navigation

You can start a new navigation by selecting a destination or route while navigating. The current navigation will stop automatically.

1. Press the [FUNC] key to display the NAVI Func screen.
2. Press the [▲] / [▼] keys to select “**Destination**” and press the [ENT] key.  
The same operation as above is possible by pressing the [1] key.



3. Select the destination or route by referring to the steps on “**Select the destination or the route**” (page 58).  
A new navigation will start.



## Save the route in memory

You can register up to 40 routes by registering memory channels that store latitude and longitude information as destinations, departure points, and waypoints.

1. Press and hold the [MENU] key to display the SETUP menu screen.
2. Select “**Memory Book**” on the screen by pressing the [▲] or [▼] key, and then press the [ENT] key.



3. Press the [▲] / [▼] keys to select “**New**” and press the [ENT] key.



4. Press the [▲] / [▼] keys to select “**Route**” and press the [ENT] key.

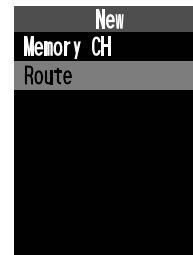

The Route screen will be displayed.

The name (tag) and group are automatically set by default, but they may be changed by the same operation as saving memory.

## Select a destination

5. Press the [▲] / [▼] keys to select “**Destination:**” and press the [ENT] key.



6. Press the [▲] / [▼] keys to select the group in which the desired memory is saved, and then press the [ENT] key.

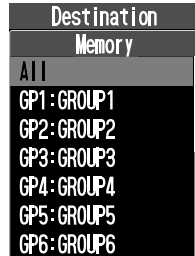

7. Press the [▲] / [▼] keys to select waypoint, and then press the [ENT] key.

- The memory where the route is stored is not displayed.
- Only the memory where the latitude / longitude information is stored is displayed.

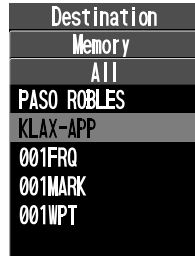

8. The set destination (e.g.: KLAX-APP) is displayed.



## Add waypoints

9. To add a waypoint, select the waypoint one line above in the order you want to add and press the [ENT] key.

If you do not want to add a stop, proceed to “Set the departure point” (step 13).



### Note:

Waypoints cannot be added if the departure point is selected.

10. Press the [▲] / [▼] keys to select “**Add**” and press the [ENT] key.

11. Add waypoints in the same way as steps 6 and 7.

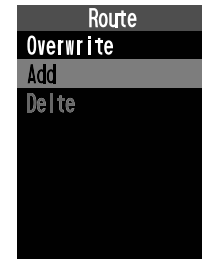

The added waypoint will be entered one step down. (e.g.: 001WPT)

12. Repeat steps 10 and 11 to add more waypoints. Up to 30 waypoints can be added to a route.

### Set the departure point (Origin)

13. Press the [▲] / [▼] keys to select “Origin:”, and then press the [ENT] key.
14. Set the departure point by the same operation as steps 6 and 7.

The set departure point will be displayed. (e.g.: PASO ROBLES)

16. Press the [▲] / [▼] keys to select “SAVE” and press the [ENT] key to save the route in memory.

This completes saving the route.



### ● Change (overwrite) waypoints

You can change the waypoints you registered while editing the route.

1. Press the [▲] / [▼] keys to select the waypoint you want to change, and then press the [ENT] key.
2. Press the [▲] / [▼] keys to select “Overwrite” and then press the [ENT] key.
3. Select the memory to overwrite by the same operation as 6 and 7.

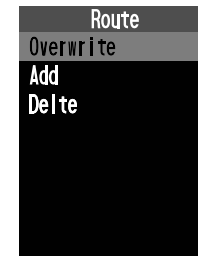

## ● Delete waypoints

You can delete waypoints registered while editing a route.

1. Press the [▲] / [▼] keys to select the waypoint you want to delete, and then press the [ENT] key.

### Note:

The determined starting point and destination cannot be deleted.

2. Press the [▲] / [▼] keys to select “Delete” and then press the [ENT] key. Waypoints will be deleted.



## Edit the stored route

You can edit the stored route in Memory Book in the setup menu.

1. Press and hold the [MENU] key to display the SETUP menu screen.

2. Select “Memory Book” on the screen by pressing the [▲] or [▼] key, and then press the [ENT] key.

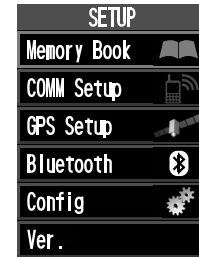

3. Press the [▲] / [▼] keys to select “New”, and then press the [ENT] key.



4. Press the [▲] / [▼] keys to select the memory group in which the route you want to edit is saved, and press the [ENT] key.

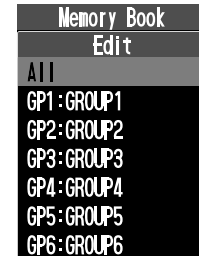

5. Press the [▲] or [▼] key to select the route to edit, and then press the [ENT] key.



6. Edit the route by referring to “Save the route in memory” (page 64).

### Delete the stored route

1. Press and hold the [MENU] key to display the SETUP menu screen.
2. Select “Memory Book” on the screen by pressing the [▲] or [▼] key, and then press the [ENT] key.
3. Press the [▲] / [▼] keys to select “Delete”, and then press the [ENT] key.



4. Press the [▲] / [▼] keys to select the memory group in which the route you want to delete is saved, and press the [ENT] key.
5. Press the [▲] or [▼] key to select the route you want to delete, and then press the [ENT] key.
6. The confirmation screen will be displayed. To delete, press the [▲] or [▼] key to select “OK”, and then press the [ENT] key.



## TIMER FUNCTION

The **FTA-850L** are provide a “Stopwatch” timer and a “Countdown” timer. These can be used for a variety of time-keeping purposes.

Even while the timer is in operation, you can move to the other operation modes to receive, transmit, scan, etc.

### Using the stopwatch timer

1. Press the [MENU] key to display the MENU screen.
2. Select “TIMER” on the screen by pressing the [▲] or [▼] key, and then press the [ENT] key.
3. Select “STOPWATCH” on the screen by pressing the [▲] or [▼] key, and then press the [ENT] key.



4. To start the counting, select “START” on the screen by pressing the [▲] or [▼] key, and then press the [ENT] key.

The displayed time will increase and “START” changes to “STOP”.

The “📶” icon appears on the top right of the display while counting.

5. To stop the counting, select “STOP” and press the [ENT] key.

To resume the counting, select “START” changed from “STOP” and press the [ENT] key again.

6. To clear the count, select “RESET” on the screen by pressing the [▲] or [▼] key, and then press the [ENT] key.

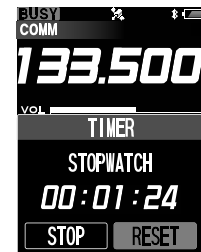
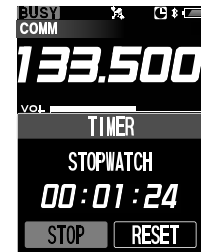
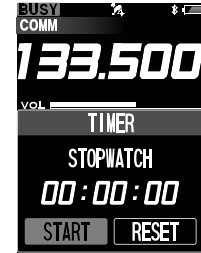

If **“RESET”** is selected while counting, the timer will continue to count from **“00:00:00”**.

If **“RESET”** is selected while stopping, the displayed time will be changed to **“00:00:00”** and the timer will keep stopping.

**Note:**

You may change the receive frequency while counting. Press the **[BACK]** key to display the recall screen listing the frequencies you have used temporarily on the display, so that you may select a frequency from the list with the **[▲]** or **[▼]** key or change the frequency with the DIAL knob. Press the **[BACK]** key again to return to the Timer screen.

**Using the countdown timer**

1. Press the **[MENU]** key to display the MENU screen.
2. Select **“TIMER”** on the screen by pressing the **[▲]** or **[▼]** key, and then press the **[ENT]** key.
3. Press the **[ENT]** key.

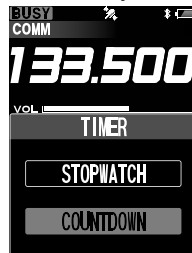

4. Press the **[▲]** or **[▼]** key to move the cursor to hour, minute, or second.
5. Input the time with the keypad or the DIAL knob, and then press the **[ENT]** key. Press the **[BACK]** key to cancel the input time.

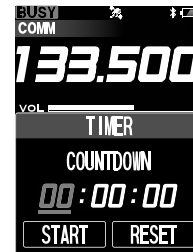

6. To start the counting, select **“START”** on the screen by pressing the **[▲]** or **[▼]** key, and then press the **[ENT]** key. The displayed time will decrease and **“START”** changes to **“STOP”**.

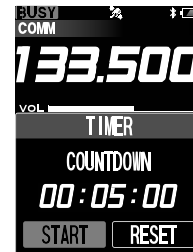

The **“G”** icon appears on the top right of the display while counting.

7. To stop the counting, select **“STOP”** and press the **[ENT]** key. To resume the counting, select **“START”** changed from **“STOP”** and press the **[ENT]** key again.





8. To clear the count, select “RESET” on the screen by pressing the [▲] or [▼] key, and then press the [ENT] key.

The displayed time will be changed to “00:00:00” and the timer will stop.

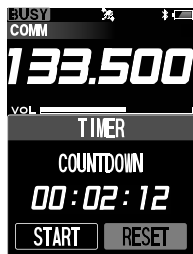

**Note:**

You may change the receive frequency while counting. Press the [BACK] key to display the recall screen listing the frequencies you have used temporarily on the display, so that you may select a frequency from the list with the [▲] or [▼] key or change the frequency with the DIAL knob. Press the [BACK] key again to return to the Timer screen.

- When the countdown timer reaches “00:00:00”, the beeps will continuously sound and “Timer Alarm!” will be displayed on the screen. Press any key to stop the beeps.

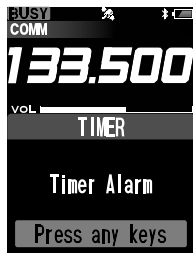

- You can set the timer to alarm without beeps. Select “OFF” on the item “TIMER ALARM” of the CONFIGURATION menu in the SETUP mode.

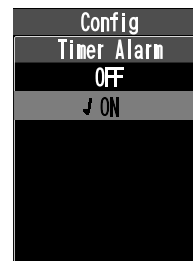

## GPS FUNCTION

The **FTA-850L** has an internal GPS reception unit to receive and display the position information at all times. The position information of your own as well as received stations can be memorized and utilized later for navigation.

### Activating the GPS Unit

1. Press and hold the **[MENU]** key to display the SETUP menu screen.
2. Select “**GPS Setup**” on the screen by pressing the **[▲]** or **[▼]** key, and then press the **[ENT]** key.
3. Select “**GPS ON/OFF**” on the screen by pressing the **[▲]** or **[▼]** key, and then press the **[ENT]** key.

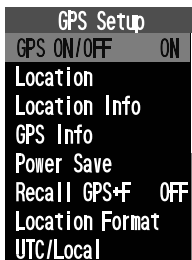

4. Select “**ON**” on the screen by pressing the **[▲]** or **[▼]** key, and then press the **[ENT]** key.

The GPS unit is set to ON and the display will return to the GPS SETUP menu.

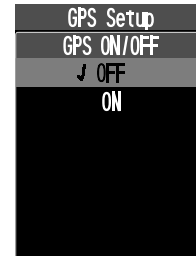

The “**GPS**” icon will appear on the top of the display when returning to the screen of the COMM, MR, or other operation mode.

### Notes:

- The GPS unit is set to **ON** by default.
- To reduce the power consumption, you are recommended to turn the GPS unit OFF if unnecessary.

### Displaying the Position Information

You can choose the way to display the position information from three types; numerical, compass, and numerical with GPS status.

### Notes:

- You may change the unit of displayed measurements via the SETUP mode.
- You may set the time area and offset via the SETUP mode.
- The position information will be displayed with the screen type you have selected last time before switching the operation mode or turning off the radio.

## ● Location Information screen

1. Press and hold the [MENU] key to display the SETUP menu screen.
2. Select “GPS Setup” on the screen by pressing the [▲] or [▼] key, and then press the [ENT] key.
3. Select “Location Info” on the screen by pressing the [▲] or [▼] key, and then press the [ENT] key.

The latitude and longitude of your current position, COG (course over ground), SOG (speed over ground), altitude, and the date will be displayed.

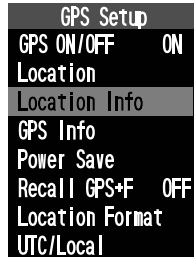

## Note:

The power save operation of the GPS unit is disabled while displaying the position information.

## ● GPS Information screen

1. Press and hold the [MENU] key to display the SETUP menu screen.
2. Select “GPS Setup” on the screen by pressing the [▲] or [▼] key, and then press the [ENT] key.
3. Select “GPS Info” on the screen by pressing the [▲] or [▼] key, and then press the [ENT] key.

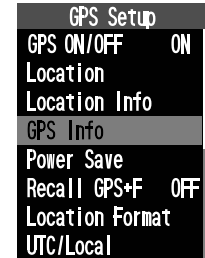

The latitude and longitude of your current position, a radar scope showing the position of captured GPS satellites, bars indicating the signal strength of captured GPS satellites, and the date will be displayed.



## Memorizing the Position Information

You can save your position information at a certain point of time in the memory book of the radio.

1. Press and hold the [MENU] key to display the SETUP menu screen.
2. Select “GPS Setup” on the screen by pressing the [▲] or [▼] key, and then press the [ENT] key.
3. Select “Location” on the screen by pressing the [▲] or [▼] key, and then press the [ENT] key.

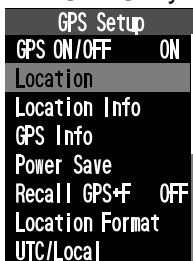

The MARK POSITION form appears on the display, with the name (tag), frequency, group tag, and current position information already filled.



- If you need no change to the items on the form, press the [SAVE] key. The position information will be stored into the memory and the display returns to the screen displayed before entering the menu mode.

- If you want to change or input either of the items in the form, press the [▲] or [▼] key to select the item, then press the [ENT] key.

Input letters and/or numerics with the keypad or the DIAL knob, then press the [ENT] key. Press the [SAVE] key after all the inputs or changes have been done to store them into the memory.

- Press the [BACK] key to cancel the changes or inputs.

## Recording the Position Information

The FTA-850L includes a logger for position information that allows you to record your location at a regular interval. The YCE46 PC Programming Software (available online) is required to copy the GPS Log data to your PC.

1. Press the [FUNC] key to display the COMM Func menu screen.
2. Select “Logger” on the screen by pressing the [▲] or [▼] key, and then press the [ENT] key.

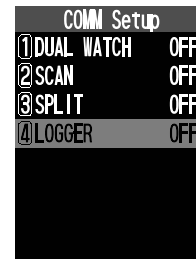

The same operation as above is possible by pressing the [4] key.

The recording starts and the display returns to the previous screen with the “” icon on the top of the display.

- You may change the interval time of recording via the SETUP mode.

# SETUP MODE

## Note:

We do not recommend that any of the default settings be changed until you are thoroughly familiar with the operation of the **FTA-850L**.

## Basic Operation

1. Press the **[MENU]** key to display the MENU screen.

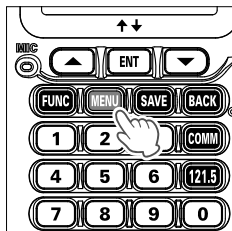

2. Select “**SETUP**” on the MENU screen by pressing the **[▲]** or **[▼]** key, and then press the **[ENT]** key.

You can also switch to the SETUP menu by press and hold the **[MENU]** key.



3. Select the item on the SETUP menu by pressing the **[▲]** or **[▼]** key, and then press the **[ENT]** key.



4. Select the item you wish to view and/or change the settings by pressing the **[▲]** or **[▼]** key, and then press the **[ENT]** key.

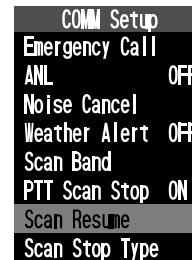

5. Enter or select settings on the screen dedicated to each item, and then press the **[ENT]** key to determine the new settings.

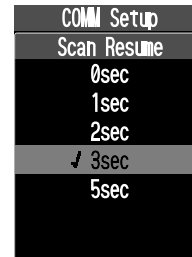

## Menu items

### ○ Memory Book

You may store the frequencies or positions with a tag name to the memory of the radio, and maintain the stored entries.

### ○ COMM Setup

You may set and adjust the operations of the radio in the COMM mode.

### ○ GPS Setup

You may set and adjust the operations of the radio in the GPS mode.

### ○ Bluetooth

You may set and pairing the operations of the Bluetooth.

### ○ Config

You may set and adjust the various conditions of the radio.

### ○ Ver.

You may confirm the version of the software currently operating on the radio.

## Maintenance of the Memory

---

See Pages 52 to 54 for details.



## Setting of the COMM Mode Operation

---



- **Turning on/off the emergency call**

You may enable or disable the quick access to the 121.500 MHz emergency frequency (see page 24).

| COMM Setup     |     | COMM Setup     |  |
|----------------|-----|----------------|--|
| Emergency Call |     | Emergency Call |  |
| ANL            | OFF | OFF            |  |
| Noise Cancel   |     | ↙ ON           |  |
| Weather Alert  | OFF |                |  |
| Scan Band      |     |                |  |
| PTT Scan Stop  | ON  |                |  |
| Scan Resume    |     |                |  |
| Scan Stop Type |     |                |  |

- **Turning on/off the ANL (Automatic Noise Limiter)**

See page 49 for details.

- **Setting the noise canceling function for both transmit and receive audio**

Reduces background noise during transmission / reception. It can be set individually for transmit and receive (4 levels).

| COMM Setup     |     | COMM Setup   |  |
|----------------|-----|--------------|--|
| Emergency Call |     | Noise Cancel |  |
| ANL            | OFF | TX Mode      |  |
| Noise Cancel   |     | RX Mode      |  |
| Weather Alert  | OFF |              |  |
| Scan Band      |     |              |  |
| PTT Scan Stop  | ON  |              |  |
| Scan Resume    |     |              |  |
| Scan Stop Type |     |              |  |

- **Turning on/off the weather alert**

You may enable or disable the alarm function when receiving the weather alert signal (see page 45).

| COMM Setup     |     | COMM Setup    |  |
|----------------|-----|---------------|--|
| Emergency Call |     | Weather Alert |  |
| ANL            | OFF | OFF           |  |
| Noise Cancel   |     | ↙ ON          |  |
| Weather Alert  | OFF |               |  |
| Scan Band      |     |               |  |
| PTT Scan Stop  | ON  |               |  |
| Scan Resume    |     |               |  |
| Scan Stop Type |     |               |  |

- **Setting the scanning band**

See page 56 for details.

- **Turning on/off the scan stop with the PTT**

You may lock out the PTT switch during the scan operation (see page 55).

| COMM Setup     |     | COMM Setup    |  |
|----------------|-----|---------------|--|
| Emergency Call |     | PTT Scan Stop |  |
| ANL            | OFF | OFF           |  |
| Noise Cancel   |     | ↙ ON          |  |
| Weather Alert  | OFF |               |  |
| Scan Band      |     |               |  |
| PTT Scan Stop  | ON  |               |  |
| Scan Resume    |     |               |  |
| Scan Stop Type |     |               |  |

- **Setting the scan resume time**

You may select a waiting time till the resuming of scan after the encountered signal disappears (see page 55).

| COMM Setup     |     | COMM Setup  |  |
|----------------|-----|-------------|--|
| Emergency Call |     | Scan Resume |  |
| ANL            | OFF | 0sec        |  |
| Noise Cancel   |     | 1sec        |  |
| Weather Alert  | OFF | 2sec        |  |
| Scan Band      |     | ↓ 3sec      |  |
| PTT Scan Stop  | ON  | 5sec        |  |
| Scan Resume    |     |             |  |
| Scan Stop Type |     |             |  |

- **Setting the operation after stopping a scan**

You may select either of the operations below when encountering a signal during a scan (see page 55).

**Busy Stop ...** Stays at the frequency and will not resume the scan

**5sec Stop ...** Stays at the frequency for 5 seconds and then resume the scan

**10sec Stop ...** Stays at the frequency for 10 seconds and then resume the scan

| COMM Setup     |     | COMM Setup     |  |
|----------------|-----|----------------|--|
| Emergency Call |     | Scan Stop Type |  |
| ANL            | OFF | ↓ Busy Stop    |  |
| Weather Alert  | OFF | 5sec Stop      |  |
| Noise Cancel   |     | 10sec Stop     |  |
| Scan Band      |     |                |  |
| PTT Scan Stop  | ON  |                |  |
| Scan Resume    |     |                |  |
| Scan Stop Type |     |                |  |

- **Setting the polled frequency for dual watch**

See page 46 for details.

- **Setting the transmit frequency during the NAV band reception**

See page 43 for details.

- **Setting the frequency step for tuning**

See page 49 for details.

- **Setting the time-out timer for transmission**

See page 47 for details.

- **Setting the microphone configuration**

See page 48 for details.

- **Setting the side tone operation**

See page 48 for details.

- **Setting the audio filter of the receiver**

You may select the operation of the audio filter from the following 4 types.

**Normal ...** No filtering

**Low Cut ...** Cuts off the lower range of sound

**High Cut ...** Cuts off the higher range of sound

**High And Low Cut ...** Cuts off the higher and lower ranges of sound



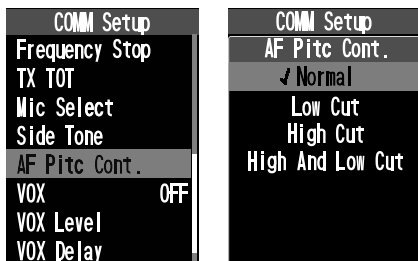

- **Turning on/off the VOX operation**

See page 37 for details.

- **Setting the sensitivity of the VOX system**

See page 37 for details.

- **Setting the sensing time of the VOX system**

See page 37 for details.

### Setting of the GPS Mode Operation

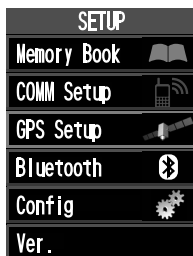

- **Turning on/off the internal GPS unit**

See page 72 for details.

- **Memorizing the Position Information**

See page 74 for details.

- **Displaying the Location Information**

See page 73 for details.

- **Displaying the GPS Information**

See page 73 for details.

- **Setting the power save operation of the internal GPS unit**

You may select an interval time of periodical operation of the GPS unit to reduce battery consumption (see also page 72).

**OFF** ... Operates all the time

**Auto** ... Sleeps until a GPS signal is received or the radio enters the GPS or NAVI mode

**50%** ... Sleeps for 3 sec after 3 sec operation

**75%** ... Sleeps for 9 sec after 3 sec operation

**90%** ... Sleeps for 27 sec after 3 sec operation

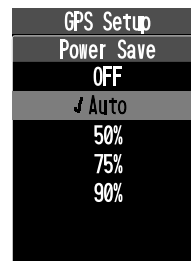
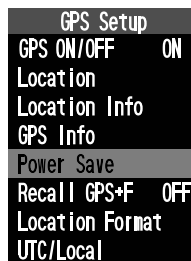

● **Turning on/off the recall of the frequency during the NAVI mode**

You may tune the radio to the frequency of the marked position set as the destination of the waypoint navigation, if the position has been saved with its frequency (see page 72).

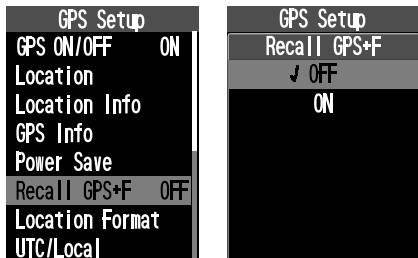

● **Setting the notation format of location**

You may select the coordinate system for position information to be shown on the display.

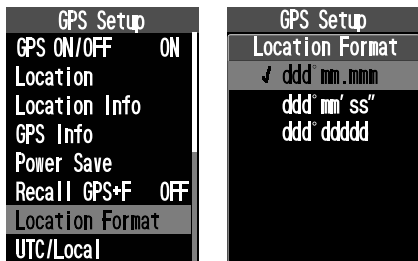

● **Setting the time area**

You may select either of the UTC (universal time coordinated) time or local time to be shown on the display (see page 72).

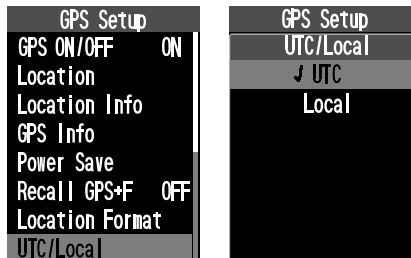

● **Setting the time offset**

You must set the time offset of your current area when using the local time (see page 72).

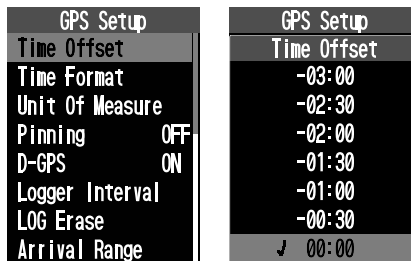

● **Setting the notation format of time**

You may select either of the 24hour or 12hour notation of time to be shown on the display (see page 72).

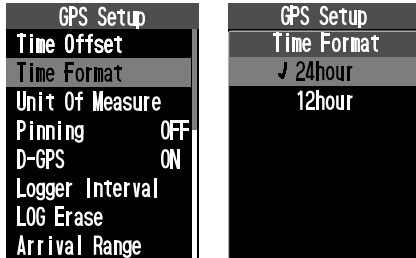

● **Setting the unit of measurement**

You may select the unit of speed, distance, and altitude to be shown on the display (see page 72).

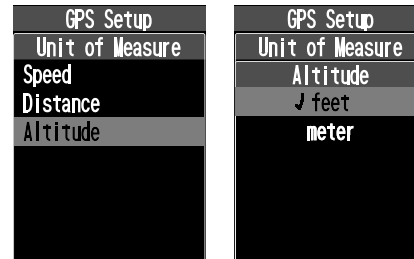
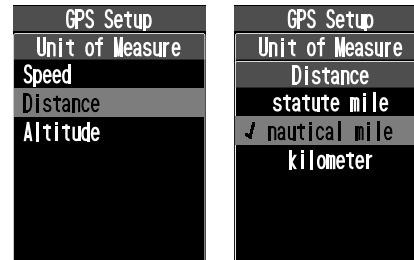
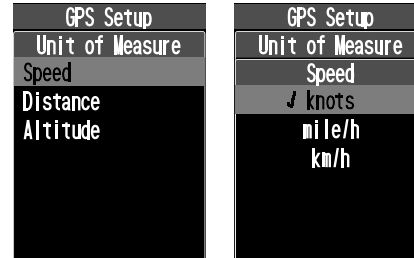
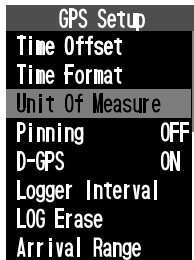

### ● Turning on/off the pinning

You may enable or disable the update of the position information when you have stayed at a location for a certain period of time.

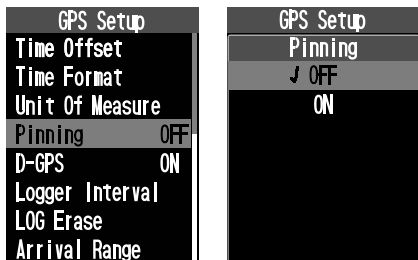

### ● Turning on/off the differential GPS feature

You may use the SBAS (satellite-based augmentation system) while obtaining the position information.

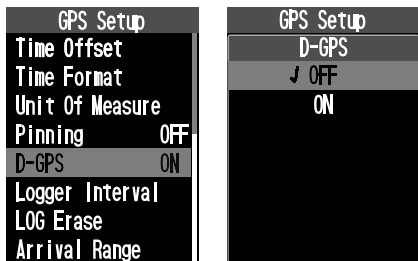

### ● Setting the interval time of logging

You may select a time rate for recording of the position information obtained from the GPS (see page 74).

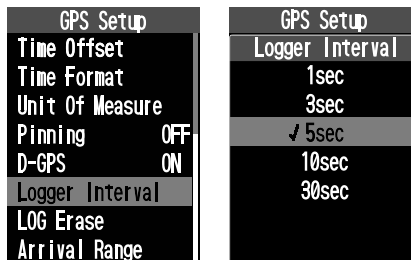

### ● Erasing the log

You may delete the records of the position information obtained from the GPS (see page 74).

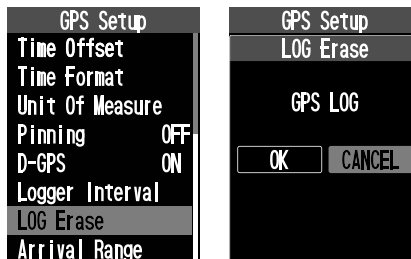

### ● Setting the Arrival Range

You may select an determines the arrival range distance. An alert will sound when your aircraft navigates to within the arrival range of the designated waypoint.  
**164 feet / 328 feet / 656 feet / 1640 feet / 1969 feet / 2297 feet / 2625 feet / 2953 feet / 0.54 mile / 0.81 mile / 1.08 mile / 1.62 mile / 2.16 mile / 2.70 mile / 3.24 mile**

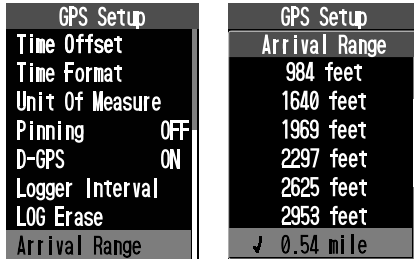

### Setting of the Bluetooth Operation

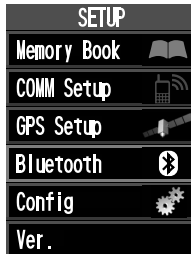

See Pages 32 to 35 for details.

### Setting of the Operation and Configuration of the Radio



### ● Setting the brightness of the display

You may adjust the dimmer in 7 levels.

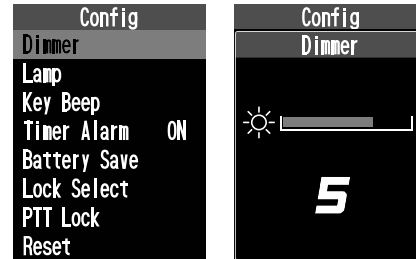

### ● Setting the lamp of the display

You may select the operation of the display lighting from the following 3 types.

**Continuous** .... Lights at all time

**5sec / 10sec / 30sec / 60sec / 120sec / 180sec**

..... Lights for selected time when any key is pressed

**EXT PO/Key** ... Lights for 5 seconds only when any key is pressed, or lights at all time when the power is supplied through the **EXT DC** jack

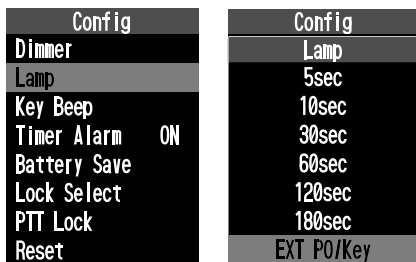

### ● Setting the loudness of key beeps

You may adjust the loudness in 5 levels.

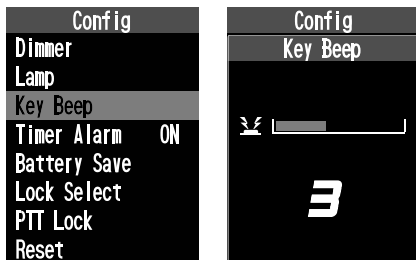

### ● Turning on/off the timer alarm

See page 71 for details.

### ● Setting the battery save operation

See page 47 for details.

### ● Setting the lockout configuration

See page 28 for details.

### ● Setting the PTT lock configuration

See page 50 for details.

### ● Resetting the radio

You may initialize the memories and settings of the menu categories independently or all at once (see also Pages 29).

**Function** ... Initializes the on/off settings in the Func menu

**Memory** ... Clears the entries in the memory

**COMM** ... Initializes the settings in the COMM Setup menu

**GPS** ... Initializes the settings in the GPS Setup menu

**Configuration** ... Initializes the settings in the Configuration menu

**Factory** ... Resets the radio to factory default

## About the Radio

*You may confirm the version of the software currently operating on the radio.*

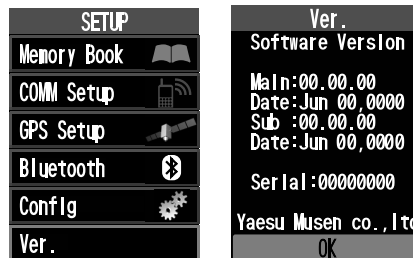

## Summary of the SETUP Menu

### ● Memory Book

| Item       | Description                                | Default Value  |
|------------|--|--|
| New        | Adding new channels or destinations        | –  |
| Edit       | Editing the stored information             | –  |
| Delete     | Deleting the stored channel or destination | –  |
| Group Name | Editing the group name                     | GP1:GROUP1<br>GP2:GROUP2<br>GP3:GROUP3<br>GP4:GROUP4<br>GP5:GROUP5<br>GP6:GROUP6<br>GP7:GROUP7<br>GP8:GROUP8<br>GP8:GROUP9 |

### ● COMM Setup

| Item           | Description                                | Default Value |
|----------------|--|---------------|
| Emergency Call | Turning on/off the emergency call          | ON            |
| ANL            | Turning on/off the automatic noise limiter | OFF           |
| Noise Cancel   | TX Mode                                    | OFF           |
|                | RX Mode (4 level)                          | OFF           |
| Weather Alert  | Turning on/off the weather alert           | OFF           |
| Scan Band      | Selecting the scanning band                | ALL Band      |
| PTT Scan Stop  | Turning on/off the scan stop with the PTT  | ON            |

| Item             | Description  | Default Value |
|------------------|--|---------------|
| Scan Resume      | Setting the scan resume time                                 | 3 sec         |
| Scan Stop Type   | Setting the operation after stopping a scan                  | Busy Stop     |
| Dual Watch Freq. | Setting the polled frequency for dual watch                  | –             |
| Split Frequency  | Setting the transmit frequency during the NAV band reception | –             |
| Frequency Step   | Setting the frequency step for tuning                        | 25 kHz        |
| TX TOT           | Setting the time-out timer for transmission                  | 5 min         |
| Mic Select       | Setting the microphone configuration                         | INT Mic       |
| Side Tone        | Setting the side tone operation                              | OFF           |
| AF Pitch Cont.   | Setting the audio filter of the receiver                     | Normal        |
| VOX              | Turning on/off the VOX operation                             | OFF           |
| VOX Level        | Setting the sensitivity of the VOX system                    | Level2        |
| VOX Delay        | Setting the sensing time of the VOX system                   | 1.5sec        |

## ● GPS Setup

| Item            | Description   | Default Value |
|-----------------|---|---------------|
| GPS ON/OFF      | Turning on/off the internal GPS unit                            | ON            |
| Location        | Memorizing the Position Information                             | -             |
| Location Info   | Displaying the current position                                 | -             |
| GPS Info        | Displaying the numerical display with GPS status                | -             |
| Power Save      | Setting the power save operation of the internal GPS unit       | Auto          |
| Recall GPS + F  | Turning on/off the recall of the frequency during the NAVI mode | OFF           |
| Location Format | Setting the notation format of location                         | ddd°mm.mmm    |
| UTC/Local       | Setting the time area   | UTC           |
| Time Offset     | Setting the time offset   | 00:00         |
| Time Format     | Setting the notation format of time                             | 24hour        |
| Unit Of Measure | SPEED   | knots         |
|                 | DISTANCE  | nautical mile |
|                 | ALTITUDE  | feet          |
| Pinning         | Turning on/off the pinning                                      | OFF           |
| D-GPS           | Turning on/off the differential GPS feature                     | ON            |
| Logger Interval | Setting the interval time of logging                            | 5 sec         |
| LOG Erase       | Erasing the log   | -             |
| Arrival Range   |   | 0.54 mile     |

## ● Bluetooth

| Item      | Description  | Default Value |
|-----------|--|---------------|
| Bluetooth | Turning on/off the internal Bluetooth unit             | OFF           |
| Device:   | Displaying the Bluetooth device list                   | -             |
| New       | Searching the Bluetooth device                         | -             |
| Mic Sence | Setting the microphone sensitivity of Bluetooth device | 7             |

## ● Config

| Item          | Description                                     | Default Value |
|---------------|---|---------------|
| Dimmer        | Setting the brightness of the display           | 5             |
| Lamp          | Setting the lamp of the display                 | EXT PO/Key    |
| Key Beep      | Setting the loudness of key beeps               | 3             |
| Timer Alarm   | Turning on/off the timer alarm                  | ON            |
| Battery Saver | Setting the power save operation                | 50%           |
| Lock Select   | Setting the lockout configuration               | Key Lock      |
| PTT Lock      | Turning enable or disable the PTT Lock function | All Unlock    |
| Reset         | Resetting the radio                             | -             |

## ● Ver.

| Item | Description                            | Default Value |
|------|--|---------------|
| -    | Confirming the version of the software | -             |



## SPECIFICATIONS

### General

|                                |  |
|--------------------------------|--|
| Frequency Range:               | <i><b>TX: 118.000 to 136.9916 MHz</b></i><br><i><b>RX: 108.000 to 136.9916 MHz (NAV and COM bands)</b></i><br><i><b>161.650 to 163.275 MHz (Weather Channels; USA/Canada only)</b></i><br><i><b>329.150 to 335.000 MHz (Glide slope)</b></i> |
| Channel Spacing:               | <i><b>25 /8.33* kHz</b></i>  |
| Emission Type:                 | <i><b>TX: AM</b></i><br><i><b>RX: AM &amp; FM (FM: for receiving the Weather Channels)</b></i>   |
| Supply Voltage:                | <i><b>6.0 to 9.5 VDC</b></i>   |
| Current Consumption (approx.): | <i><b>300 <math>\mu</math>A (power off),</b></i><br><i><b>125 mA (battery saver on, saver ratio 50%)</b></i><br><i><b>160 mA (squelch on),</b></i><br><i><b>300 mA (receive),</b></i><br><i><b>1.1 A (transmit 1.8 W Carrier)</b></i>        |
| Temperature Range:             | <i><b>+14 °F to + 140 °F (-10 °C to +60 °C)</b></i>  |
| Case Size (W x H x D):         | <i><b>2.4 x 5.2 x 1.3 inches (60 x 132 x 34 mm) with SBR-39LI</b></i>  |
| Weight (approx.):              | <i><b>13.9 oz (395 g) with SBR-39LI, antenna and belt clip</b></i>   |

### Receiver

|                           |  |
|---------------------------|--|
| Circuit Type:             | <i><b>Double-conversion superheterodyne</b></i>  |
| IFs:                      | <i><b>47.25 MHz (VHF) / 46.35 MHz (UHF) &amp; 450 kHz</b></i>                              |
| Sensitivity:              | <i><b>Better than 0.8 <math>\mu</math>V (for 6 dB S/N with 1 kHz, 30 % modulation)</b></i> |
| Selectivity:              | <i><b>&gt;8 kHz/-6 dB @ 25 kHz channel spacing</b></i>                                     |
| Adjacent CH. Selectivity: | <i><b>&lt;25 kHz/-60 dB @ 25 kHz channel spacing</b></i>                                   |
| AF Output (@7.4 V):       | <i><b>0.8 W @ 16 Ohms, 10 % THD</b></i>  |

## **Transmitter**

|                                |   |
|--------------------------------|---|
| <b>Power Output (@ 7.4 V):</b> | <b>6.0 W (PEP), 1.8 W (Carrier Power)</b>   |
| <b>Frequency Stability:</b>    | <b>Better than <math>\pm 1</math> ppm (+14 °F to + 140 °F [-10 °C to +60 °C])</b> |
| <b>Modulation System:</b>      | <b>Low Level Amplitude Modulation</b>   |
| <b>Spurious Emission:</b>      | <b>&gt;70 dB below carrier</b>  |
| <b>Int. Microphone Type:</b>   | <b>Condenser</b>  |
| <b>Ext. Mic. Impedance:</b>    | <b>150 Ohms</b>   |

## **GPS Unit**

|                          |  |
|--------------------------|--|
| <b>Receiver Channels</b> | <b>66 Channels</b>   |
| <b>Sensitivity</b>       | <b>Less than -147 dBm</b>  |
| <b>Time to First Fix</b> | <b>1 minute typical (@ Cold Start)</b><br><b>5 seconds typical (@ Hot Start)</b> |
| <b>Geodetic Datum</b>    | <b>WGS84</b>   |

## **Bluetooth**

|                      |                    |
|----------------------|--------------------|
| <b>Version:</b>      | <b>Version 4.2</b> |
| <b>Class:</b>        | <b>Class 2</b>     |
| <b>Output Power:</b> | <b>2 dBm</b>       |

***Specifications are subject to change without notice or obligation.***

The Bluetooth® wordmark and logo are registered trademarks owned by Bluetooth SIG, Inc. and are used under license by Yaesu Musen Co., Ltd.

## TROUBLESHOOTING FOR HEADSET CONNECTION

| Question  | Answer  |
|---|---|
| When connecting the <b>SCU-42</b> headset adapter cable between the radio and a headset, the "TX" icon appears on the display and the radio cannot be operated. | This happens when the plug on the <b>SCU-42</b> headset adapter cable is simply inserted into the <b>MIC/SP</b> jack.<br><br>To make proper contacts within the radio, the plug must be pushed all the way in the MIC/SP jack and be fixed with the two screws. |
| Can I purchase the optional PTT Switch from Yaesu?  | Contact your Aviation dealer for details on purchasing an aftermarket Push-To-Talk switch.  |
| Will my headset work with this radio?   | The <b>SCU-42</b> headset adapter cable is made to operate with most headsets; however to be concretely sure to check with the headset manufacturer providing the wiring shown below. Please confirm the connections and connector sizes are correct.           |

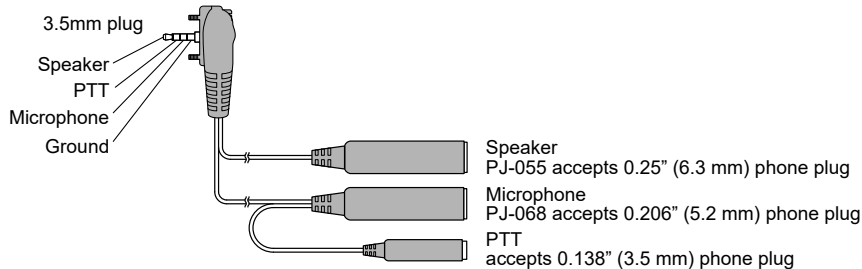

### ● Headset specification requirements for SCU-42

Earphone (speaker) impedance: 8  $\Omega$  or above

Microphone impedance: 150  $\Omega$   $\pm$ 20%

PTT pressed: Ground

PTT not pressed: Open

Under Industry Canada regulations, this radio transmitter may only operate using an antenna of a type and maximum (or lesser) gain approved for the transmitter by Industry Canada. To reduce potential radio interference to other users, the antenna type and its gain should be so chosen that the equivalent isotropically radiated power (e.i.r.p.) is not more than that necessary for successful communication.

Conformément à la réglementation d'Industrie Canada, le présent émetteur radio peut fonctionner avec une antenne d'un type et d'un gain maximal (ou inférieur) approuvé pour l'émetteur par Industrie Canada. Dans le but de réduire les risques de brouillage radioélectrique à l'intention des autres utilisateurs, il faut choisir le type d'antenne et son gain de sorte que la puissance isotrope rayonnée équivalente (p.i.r.e.) ne dépasse pas l'intensité nécessaire à l'établissement d'une communication satisfaisante.

This radio transmitter (identify the device by certification number, or model number if Category II) has been approved by Industry Canada to operate with the antenna types listed below with the maximum permissible gain and required antenna impedance for each antenna type indicated. Antenna types not included in this list, having a gain greater than the maximum gain indicated for that type, are strictly prohibited for use with this device.

Le présent émetteur radio (identifier le dispositif par son numéro de certification ou son numéro de modèle s'il fait partie du matériel de catégorie I) a été approuvé par Industrie Canada pour fonctionner avec les types d'antenne énumérés ci-dessous et ayant un gain admissible maximal et l'impédance requise pour chaque type d'antenne. Les types d'antenne non inclus dans cette liste, ou dont le gain est supérieur au gain maximal indiqué, sont strictement interdits pour l'exploitation de l'émetteur.

Part 15.21: Changes or modifications to this device not expressly approved by YAESU MUSEN could void the user's authorization to operate this device.

# SAFETY PRECAUTIONS

Yaesu is not liable for any failures or problems caused by the use or misuse of this product by the purchaser or any third party. Also, Yaesu is not liable for damages caused through the use of this product by the purchaser or any third party, except in cases where ordered to pay damages under the laws.

## Types and meanings of the marks



### DANGER

This mark indicates an imminently hazardous situation, which, if not avoided, could result in death or serious injury.



### WARNING

This mark indicates a potentially hazardous situation, which, if not avoided, could result in death or serious injury.



### CAUTION

This mark indicates a potentially hazardous situation, which, if not avoided, may result in minor or moderate injury or only property damage.

## Types and meanings of symbols



These symbols signify prohibited actions, which must not be done to use this product safely.

For example:  indicates that the product should not be disassembled.



These symbols signify required actions, which must be done to use this product safely. For example:  indicates that the power plug should be disconnected.



### DANGER



**Do not use this product in "an area where use of it is prohibited", e.g., inside the hospital or train."**  
This product can affect electronic or medical devices.



**Do not use this product while riding a bicycle or driving a car. Accidents can result.**  
Be sure to stop the bicycle or car at a safe place before using this product.



**Do not perform transmission in a crowded place for the safety of persons using a medical device such as a cardiac pacemaker.**  
The radio wave emitted from this product can cause the medical device to malfunction and result in an accident.



**Do not touch any material leaking from the battery pack with bare hands.**

The chemical that has stuck to your skin or entered your eye can cause chemical burns. In such a case, consult the doctor immediately.



**Those who are carrying a medical device such as a cardiac pacemaker should not perform transmission near the device. When transmitting, use an external antenna and keep as far as possible away from the external antenna.**

The radio wave emitted by the transmitter can cause the medical device to malfunction and result in an accident.



**Do not use this product or the battery charger in a place where inflammable gas is generated.**

A fire or explosion can occur.



**Do not solder or short-circuit the terminal of the battery pack.**

A fire, leak, overheating, explosion, or ignition can result. Do not carry the battery pack together with a necklace, hair pin, or small metal objects. A short circuit can result.



### WARNING



**Do not power this transceiver with a voltage other than the specified power supply voltage.**

A fire, electric shock, or damage may result.



**Do not use the battery pack for any model other than the specified transceiver.**

A fire, leak, overheating, explosion, or ignition can result.



**Do not make very long transmissions.**

The main body of the transceiver may overheat, resulting in a failure or burns.



**Do not disassemble or make any alteration to this product.**

An injury, electric shock, or failure can result.



When transmitting, keep the transceiver at least 5.0 mm (3/16 inch) away from your body. Use only the supplied antenna. Do not use modified or damaged antennas.



**Keep the terminals of the battery pack clean.**

If terminal contacts are dirty or corroded, a fire, leak, overheating, explosion, or ignition can result.



**Do not handle the battery pack or charger with wet hands. Do not insert or remove the power plug with wet hands.**

An injury, leak, fire, or failure can result.



If smoke or strange odor is emitted from the main body, battery pack, or battery charger, immediately turn the transceiver off; remove the battery pack, and remove the power plug from the outlet.

A fire, leak, overheating, damage, ignition, or failure can result. Contact the dealer from which you purchased this product or Yaesu Customer Support.



**Do not use the battery pack which is externally damaged or deformed.**

A fire, leak, heating, explosion, or ignition can result.



**Do not use any battery charger which is not specified by Yaesu.**

A fire or failure can result.



If charging of the battery pack cannot be completed within the specified charging time, immediately remove the power plug of the battery charger from the outlet.

A fire, leak, overheating, explosion, or ignition can result.



## CAUTION



**Do not dangle or throw this product by holding its antenna.**

This product can hit and injure someone. In addition, doing so can result in a transceiver failure or damage.



**Do not use transceiver in a crowded place.**

The antenna can hit someone, resulting in an injury.



**Do not place this transceiver in a place subject to direct sun-light or near a heater.**

The transceiver can deform or discolor.



**Do not place this transceiver in a humid or dusty place.**

A fire or failure can result.



**During transmission, keep the antenna as far from you as possible.**

Long-time exposure to electromagnetic waves can have a negative impact on your health.



**Do not clean the case with thinner or benzene.**

Use a soft, dry cloth to clean the case.



If the transceiver is not being used for an extended period, turn it off and remove the battery pack for safety.



**Do not drop, strike, or throw the transceiver.**

A failure or damage may result.



**Keep magnetic cards and video tape away from the transceiver.**

The data recorded on cash cards or video tape can be erased.



**Charge the battery pack within the temperature range from +5 °C to +35 °C (+41 °F to +95 °F).**

Charging the battery pack outside this temperature range can cause leak, overheating, decrease in performance, or reduction in service life can result.



**When unplugging the power cord of the battery charger, be sure to hold the power plug.**

Pulling the power cord can damage it and cause a fire or electronic shock.



**Do not use the earphones or head-phones at an extremely high volume level.**

Hearing impairment can result.



**Keep this product out of reach of children.**

An injury, etc. can result.



Install the belt clip securely.

If they are installed improperly, the transceiver may fall or drop, resulting in an injury or damage.



**Do not place a heavy object on the power cord of the battery charger.**

The battery cord can be damaged, resulting in a fire or electric shock.



**Do not use the included battery charger to charge any battery pack which is not specified for use with the charger.**

A fire can result.



**Do not operate the transmitter near the TV or radio.**

Radio disturbance can occur in the transceiver, the TV, or the radio.



**Do not use any products other than the specified options and accessories.**

A failure can result.



When the battery charger is not in use, remove its power plug from the outlet.



Before discarding the worn battery pack, affix tape or the like to its terminals.



Before using this transceiver in a hybrid or fuel-saving car, be sure to check with the auto-mobile manufacturer regarding use of the transceiver in that car.

Noise generated by an onboard electrical device (inverter, etc.) can disrupt the normal operation of the transceiver.



**Do not use at extremely low atmospheric pressure.**

## EU Declaration of Conformity

We, Yaesu Musen Co. Ltd of Tokyo, Japan, hereby declare that this radio equipment FTA-850 is in full compliance with EU Radio Equipment Directive 2014/53/EU. The full text of the Declaration of Conformity for this product is available to view at <http://www.yaesu.com/jp/red>

### ATTENTION – Condition of use

This transceiver works on frequencies that are regulated and not permitted to be used without authorisation in the EU countries shown in this table. Users of this equipment should check with their local spectrum management authority for licensing conditions applicable for this equipment.

|  |    |    |    |    |    |    |    |
|---|----|----|----|----|----|----|----|
| AT  | BE | BG | CY | CZ | DE | DK | ES |
| EE  | FI | FR | UK | EL | HR | HU | IE |
| IT  | LT | LU | LV | MT | NL | PL | PT |
| RO  | SK | SI | SE | CH | IS | LI | NO |

### Disposal of Electronic and Electrical Equipment

Products with the symbol (crossed-out wheeled bin) cannot be disposed of as household waste. Electronic and Electrical Equipment should be recycled at a facility capable of handling these items and their waste by products. Please contact a local equipment supplier representative or service center for information about the waste collection system in your country.



# ***YAESU***

Copyright 2021  
YAESU MUSEN CO., LTD.  
All rights reserved.

No portion of this manual may be  
reproduced without the permission of  
YAESU MUSEN CO., LTD.

## **YAESU MUSEN CO., LTD.**

Tennozu Parkside Building  
2-5-8 Higashi-Shinagawa, Shinagawa-ku, Tokyo 140-0002 Japan

## **YAESU USA**

6125 Phyllis Drive, Cypress, CA 90630, U.S.A.

## **YAESU UK**

Unit 12, Sun Valley Business Park, Winnall Close  
Winchester, Hampshire, SO23 0LB, U.K.

21070-AS  
Printed in Japan

